

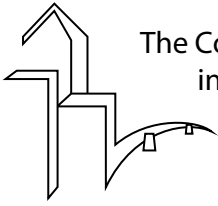

2023  
**COLORING BOOK**



The Construction Leadership Council was formed to cultivate the future leaders of Alaska's construction industry. Through the development of strong professional relationships, the group will expand and enhance the growth and development of Alaskan communities, carrying forward the tradition of excellence.

# CONSTRUCTION LEADERSHIP COUNCIL

---



Leading the future  
of Alaska's

Construction Industry

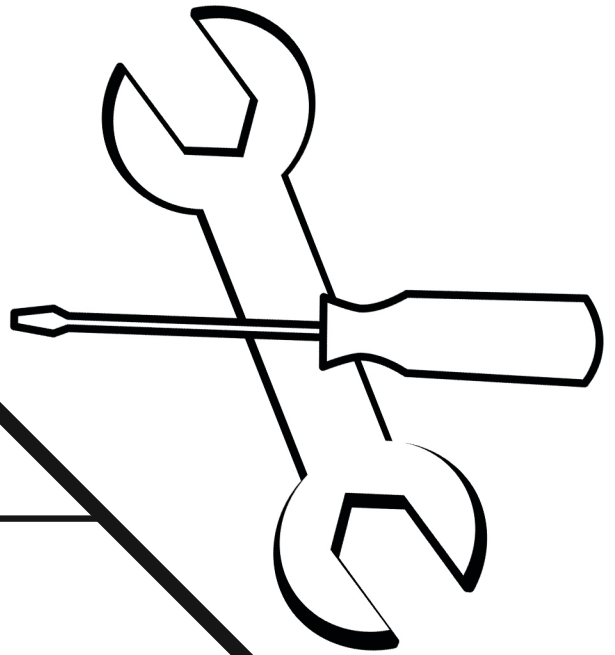
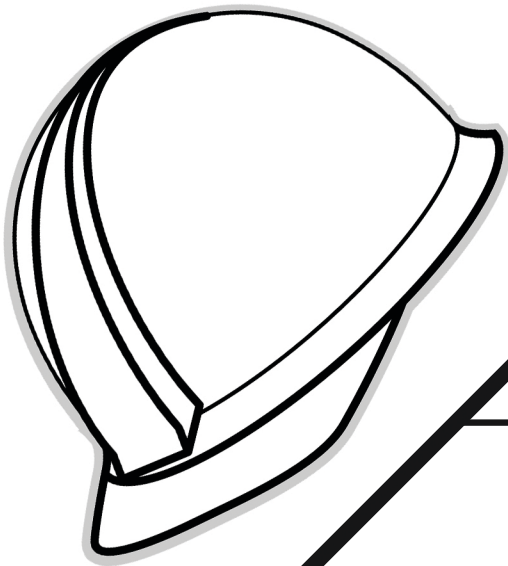

**SAFETY  
FIRST**

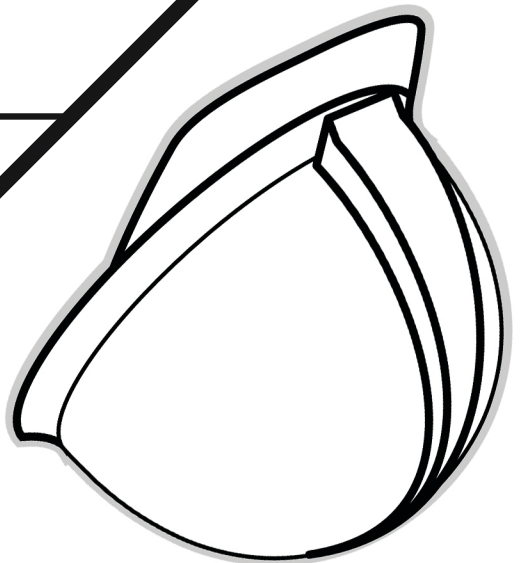
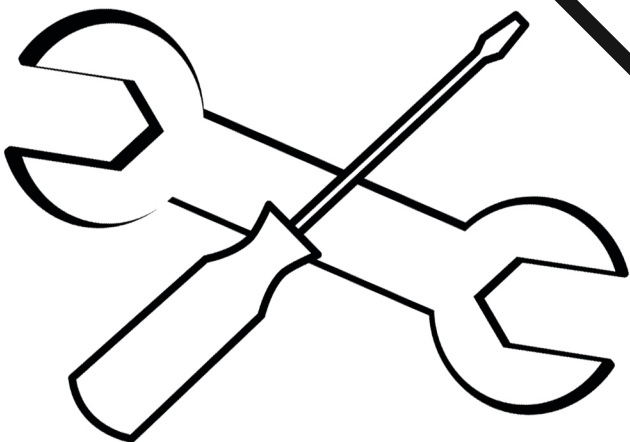

# ALCAN

ELECTRICAL & ENGINEERING

B C U R R E N T A  
I A K C S W I T C H C  
F N J B L D M E Z J F H I  
H S T A T I C R M E O L D  
G T U I P N X O Y P N G C B K  
U Q L S E L E C T R I C I T Y  
R W A V C B L O Q Y S X R T A  
I T E K U D N Z W O Y C Q  
H O J F L M D I N R P U L  
R G O B B U S E M A I  
J K U I C C T D U T  
Y H B A T T E R Y  
G W F O E A Y  
B C R D Z  
H I X G E  
W I R E F

Wire

Static

Switch

Bulb

Circuit

Current

Insulator

Conductor

Electricity

Battery





**Alaska National**<sup>™</sup>  
A CopperPoint Insurance Company

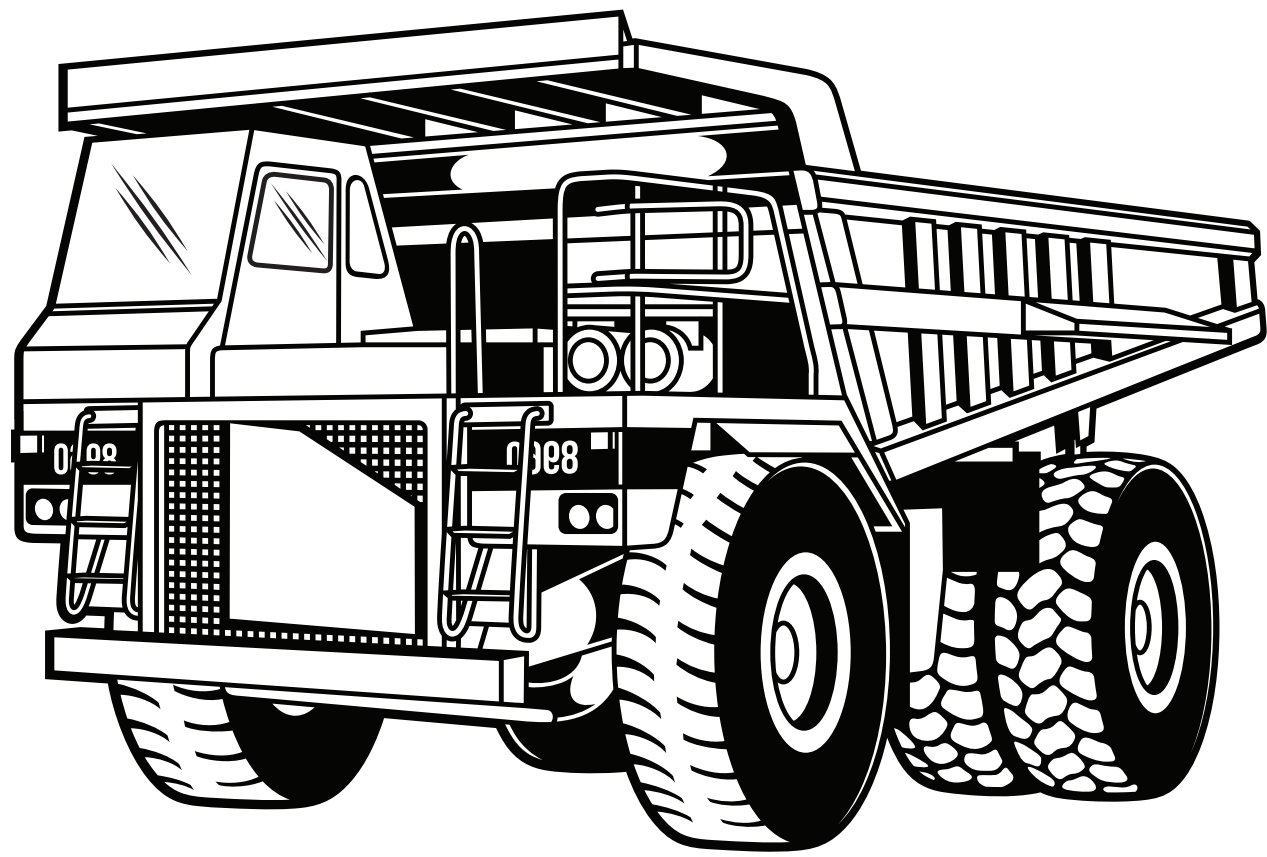

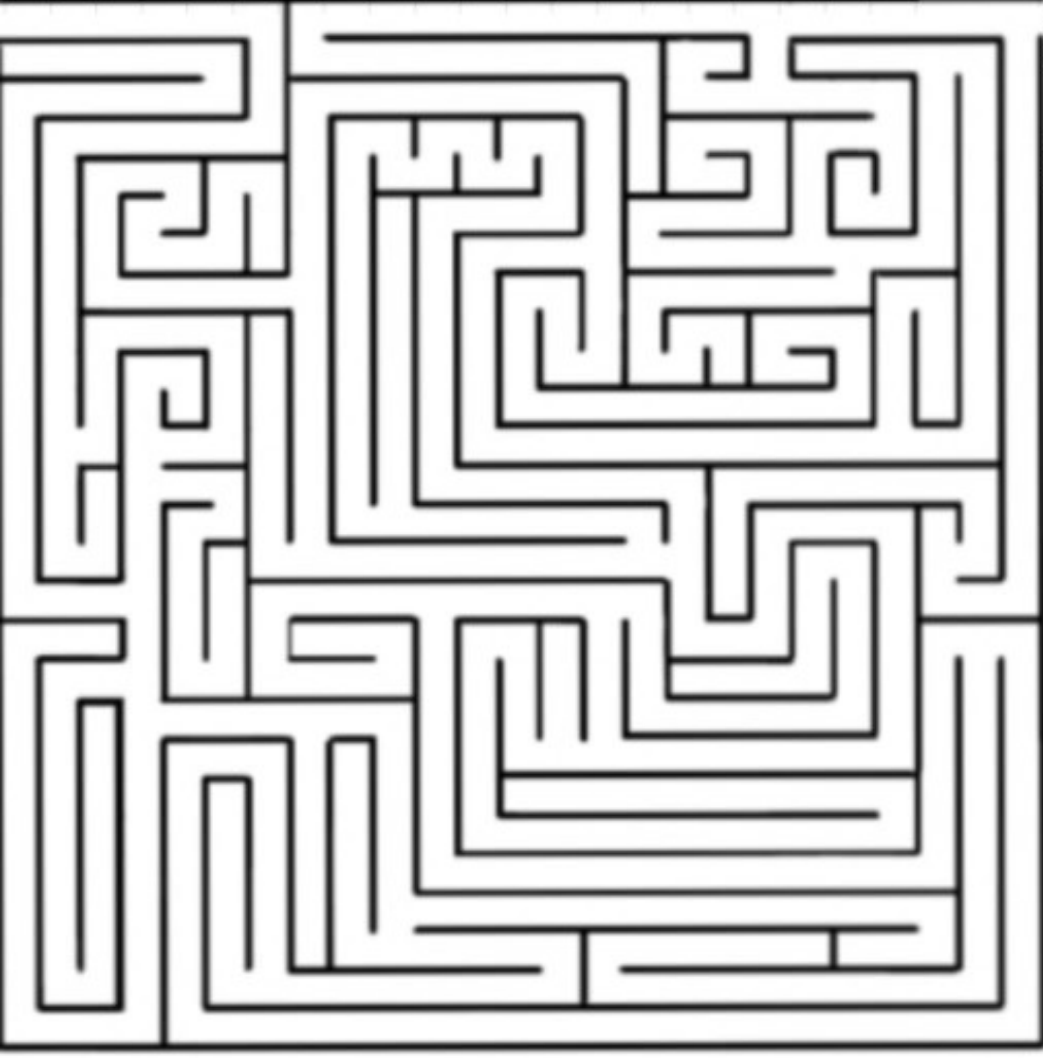

T	C	C	D	L	W	O	Y	O	S
I	A	E	F	O	M	F	O	S	A
R	Q	T	O	Y	O	T	A	P	L
E	U	H	R	E	L	S	F	H	E
S	T	T	K	W	C	L	A	A	S
H	D	O	L	P	K	B	Z	N	T
J	F	G	I	L	K	V	I	D	M
Q	R	B	F	P	A	K	L	L	A
R	E	N	T	A	L	S	F	I	T
C	N	R	M	R	S	E	T	N	E
L	T	Y	J	T	K	R	E	G	R
S	I	K	S	S	F	V	C	B	I
E	H	F	L	I	L	I	H	L	A
L	O	E	T	K	H	C	N	Q	L
L	O	G	A	Y	E	E	I	A	L
I	P	N	L	V	D	F	C	L	R
C	S	J	A	J	Y	O	I	L	D
K	T	A	S	J	Y	I	A	P	G
F	O	R	K	S	F	U	N	R	E
S	F	J	A	L	P	J	F	O	Q

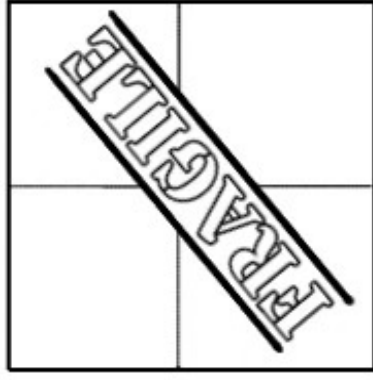

24 ● ●23

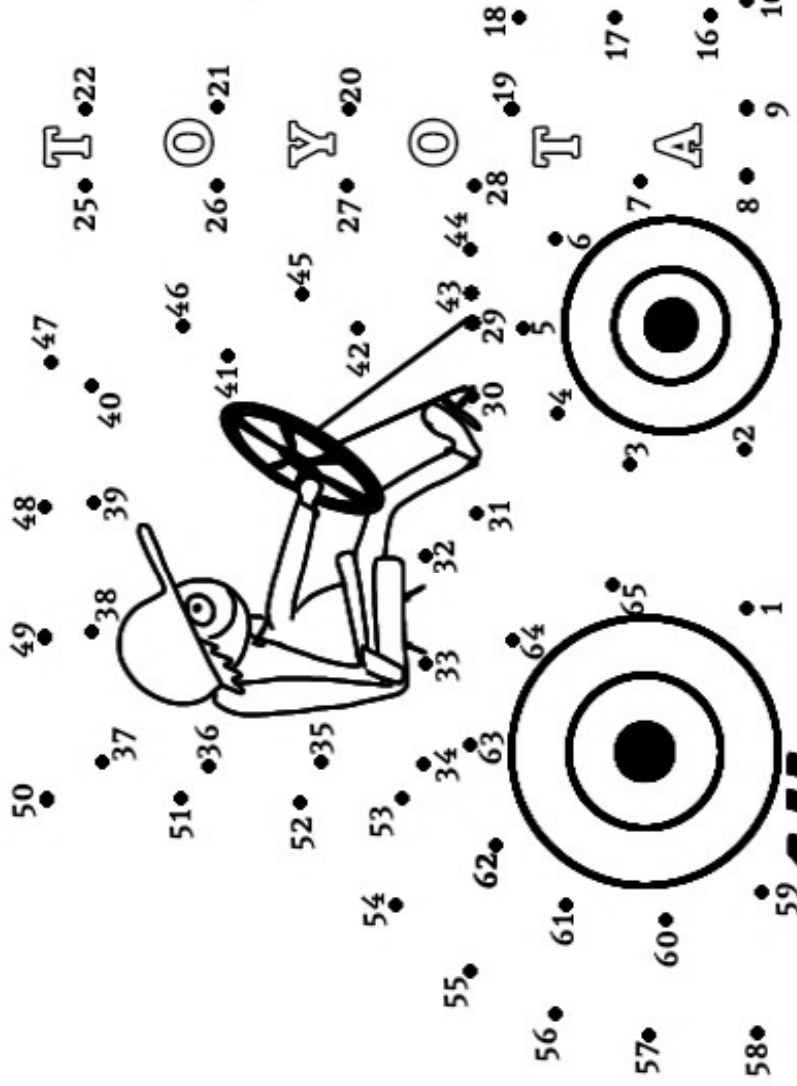

ALASKA	MATERIAL
ALL PRO	PARTS
DOOSAN	RENTALS
FORKLIFT	SALES
FORKS	SELICK
HANDLING	SERVICE
HEAVY	TECHNICIAN
LIFT	TOYOTA

**All Pro**

ALASKA FORKLIFT  
RENTALS, SALES, PARTS & SERVICES



**TOYOTA**

**MATERIAL HANDLING**



15 ● ●14  
10 ● ●13  
11 ● ●12  
9 ● ●8  
7 ● ●6  
5 ● ●4  
3 ● ●2  
1 ● ●

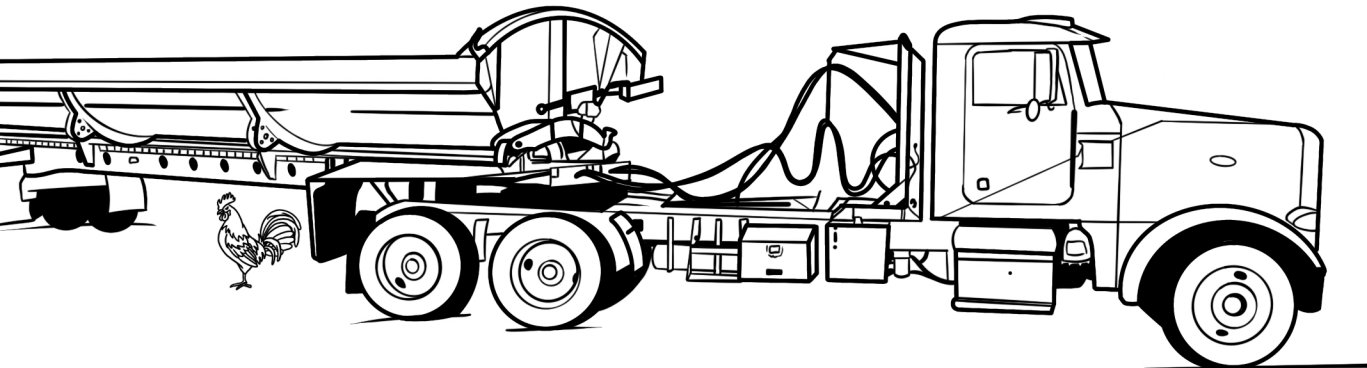
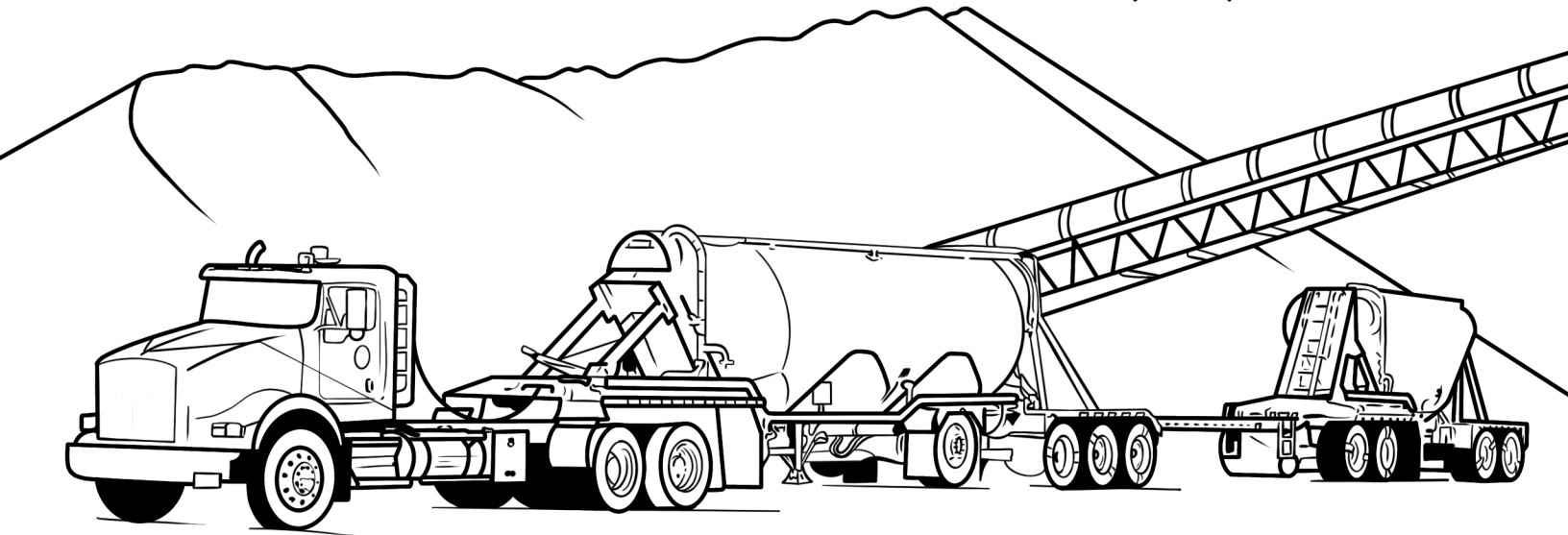
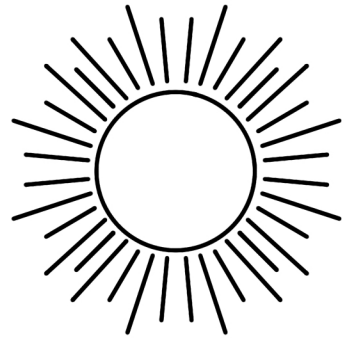

**80 Years in Alaska**



**BIG STATE  
MECHANICAL**

***COMMITTED TO QUALITY!***

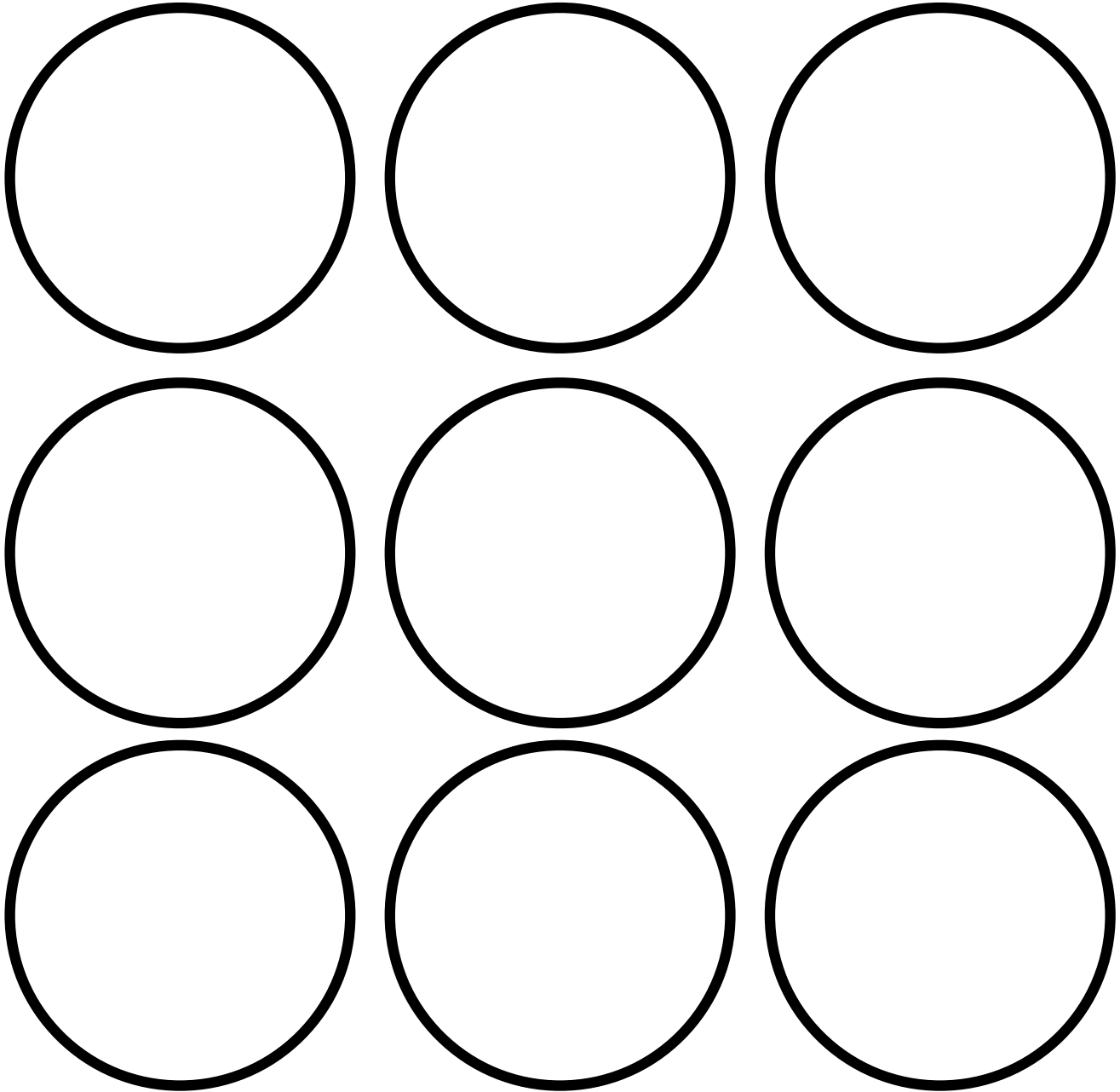
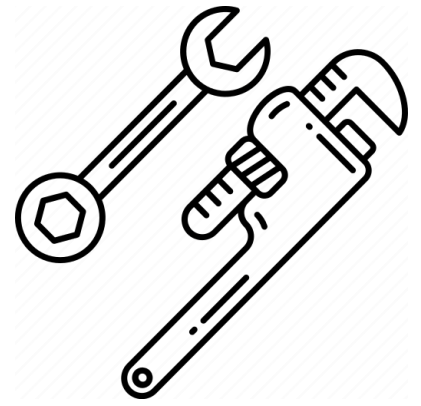

***THE CIRCLE CHALLENGE***

Directions: What are you able to make out of a circle? You have 3 minutes to turn as many circles as you can into an object



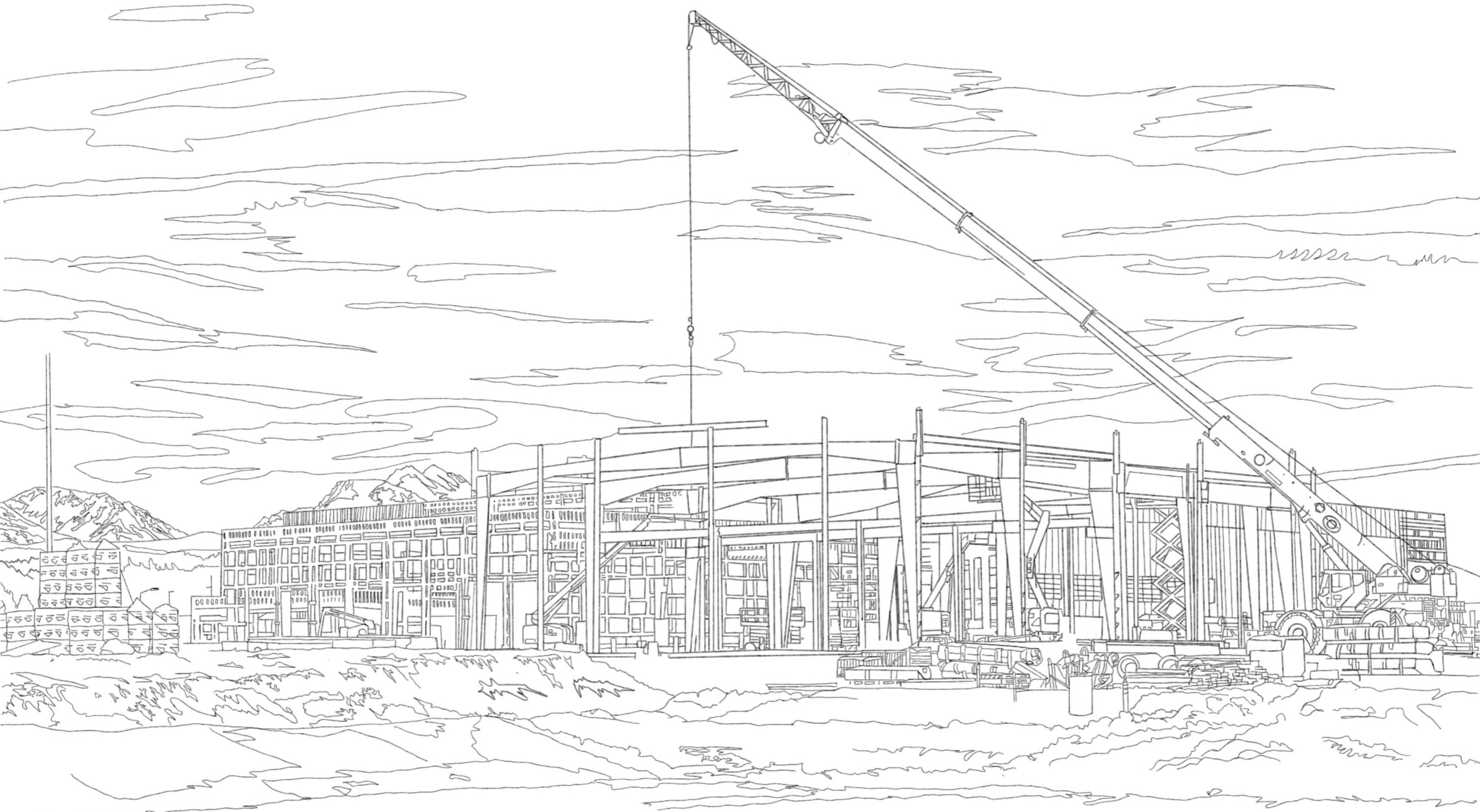

davis

CONSTRUCTORS & ENGINEERS



# CGC

SERVICES

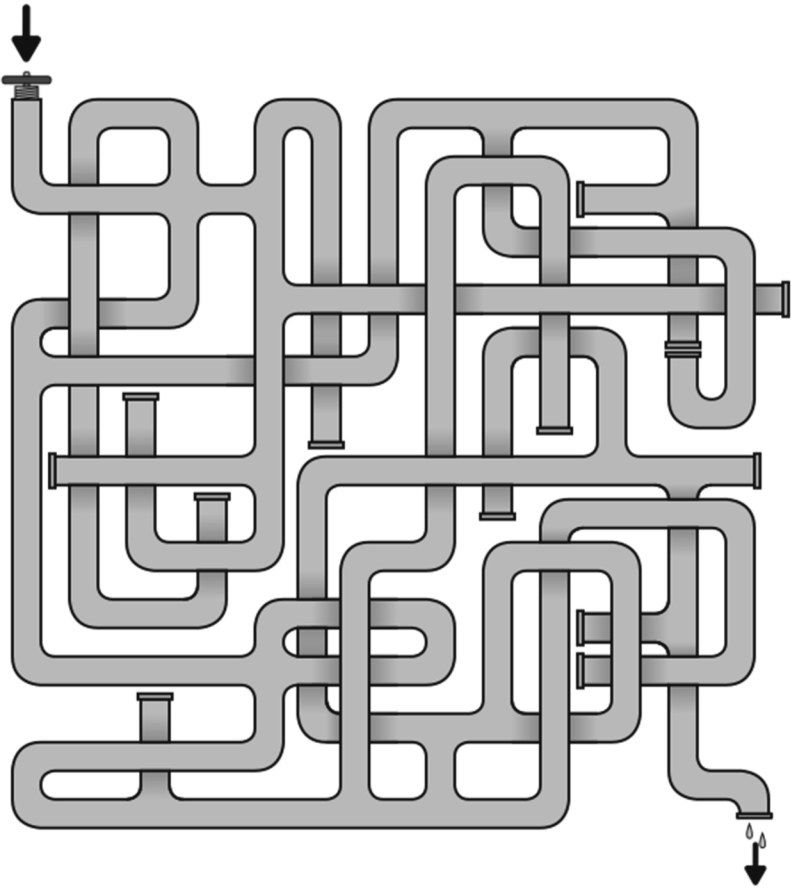
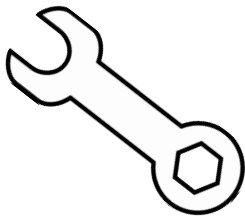
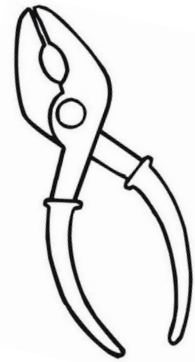



Chief Andrew Isaac  
Health Center

Fairbanks, Alaska

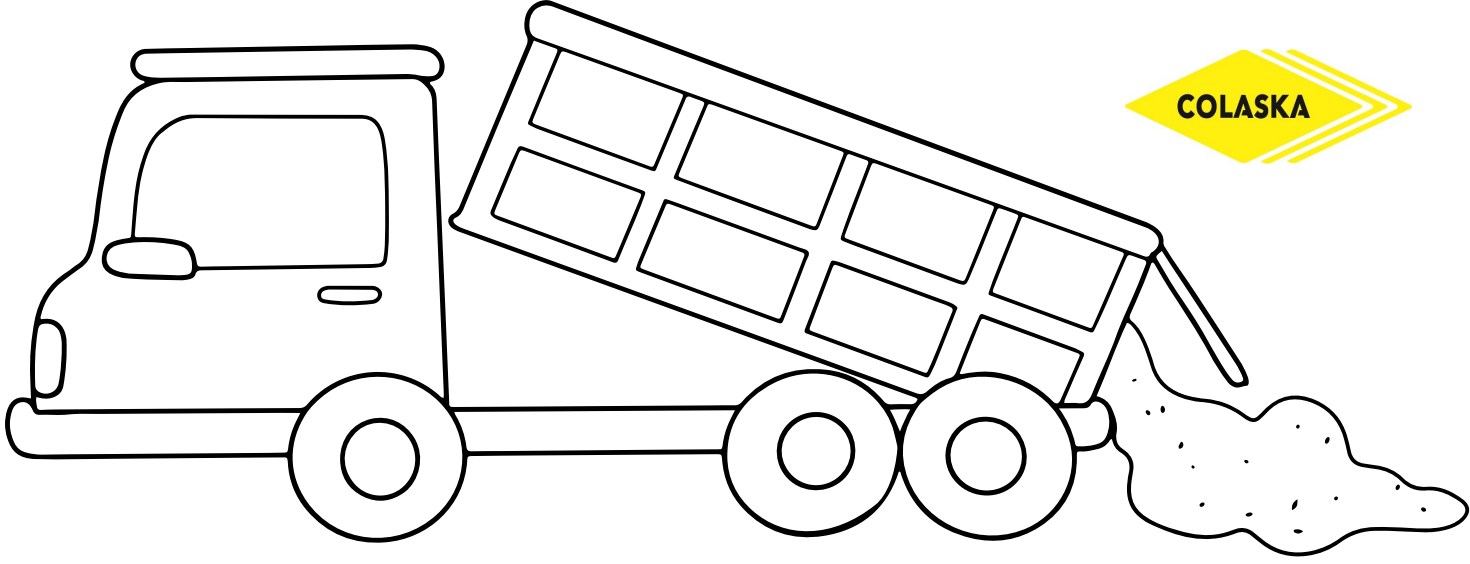

**BE SAFE**

**BE SEEN**

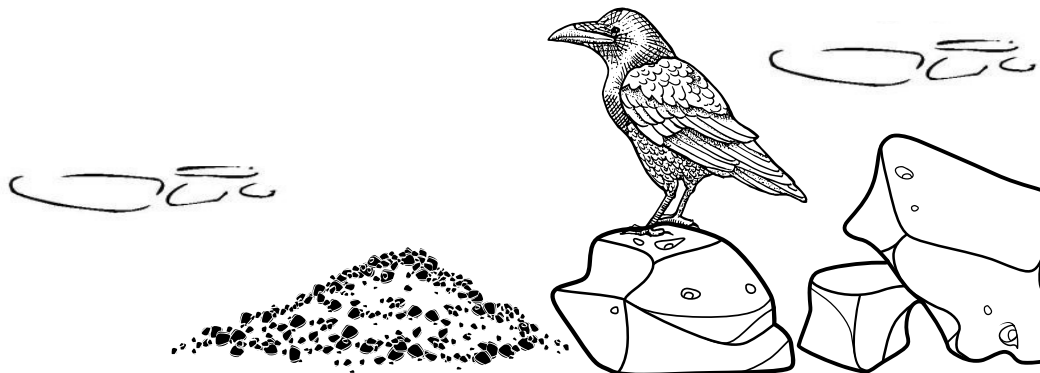
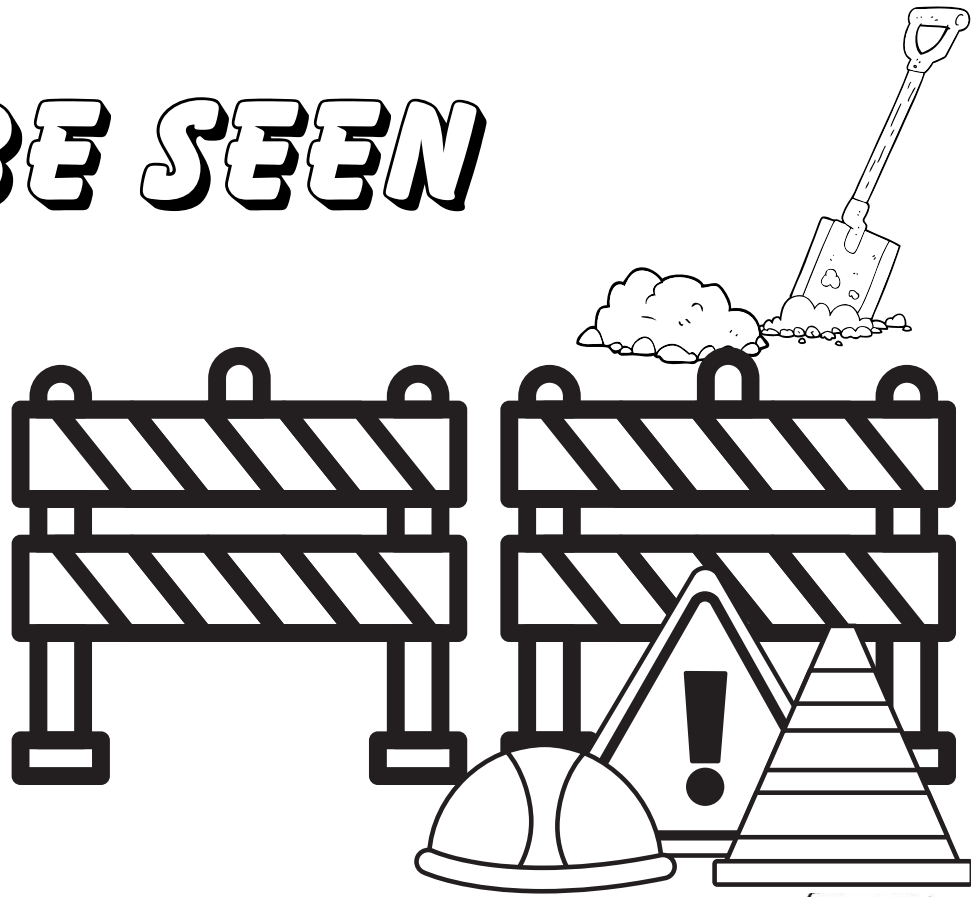
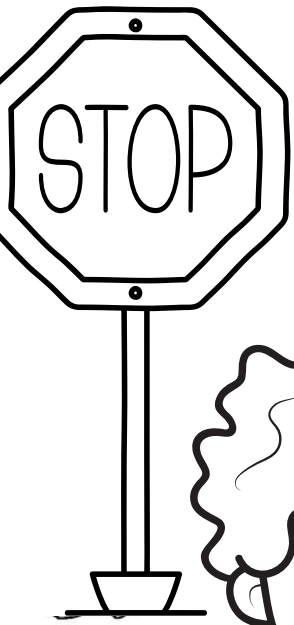

# Educating Alaskans for Alaska Jobs



## Construction Management

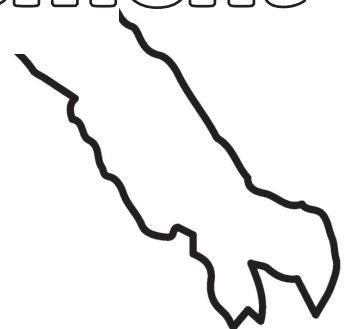

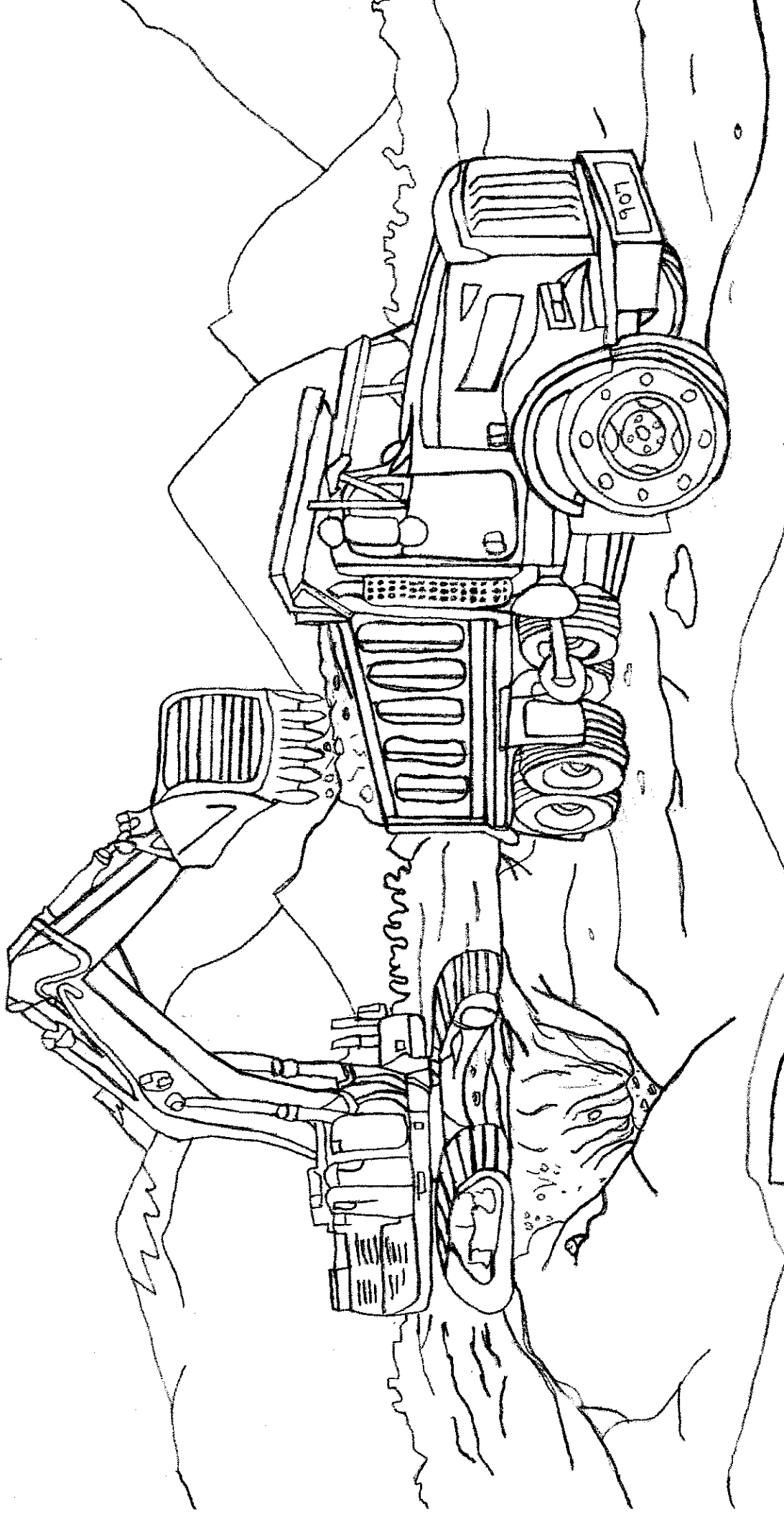

**Dirtworks**<sup>inc.</sup>

# EMULSION PRODUCTS

NORTH POLE ANCHORAGE

# A L A S K A

A COLAS COMPANY



# CALL 811 BEFORE YOU DIG



**1: Electric  
(red)**

**2: Gas  
(yellow)**

**3: Water  
(blue)**

**4: Cable  
(orange)**

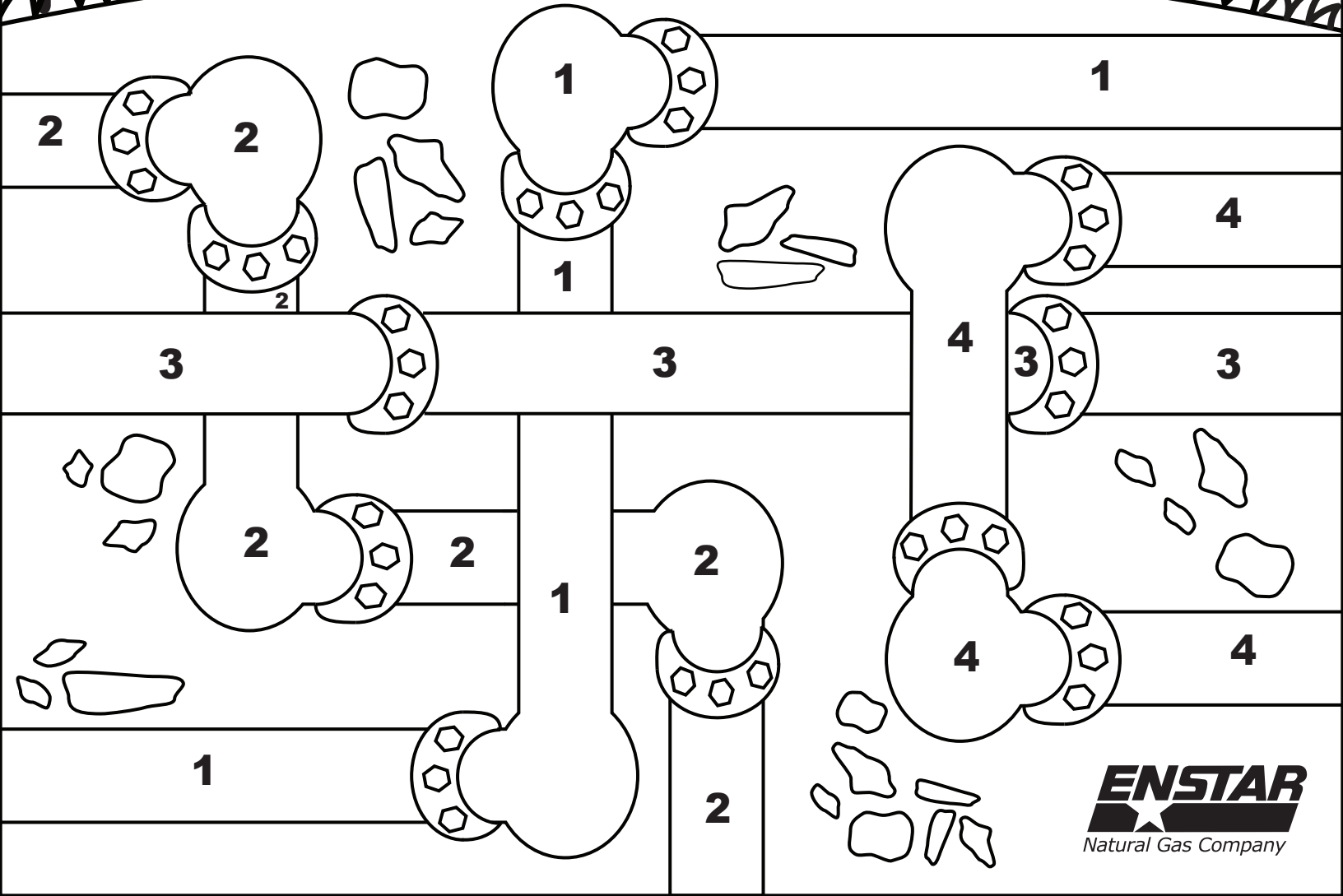



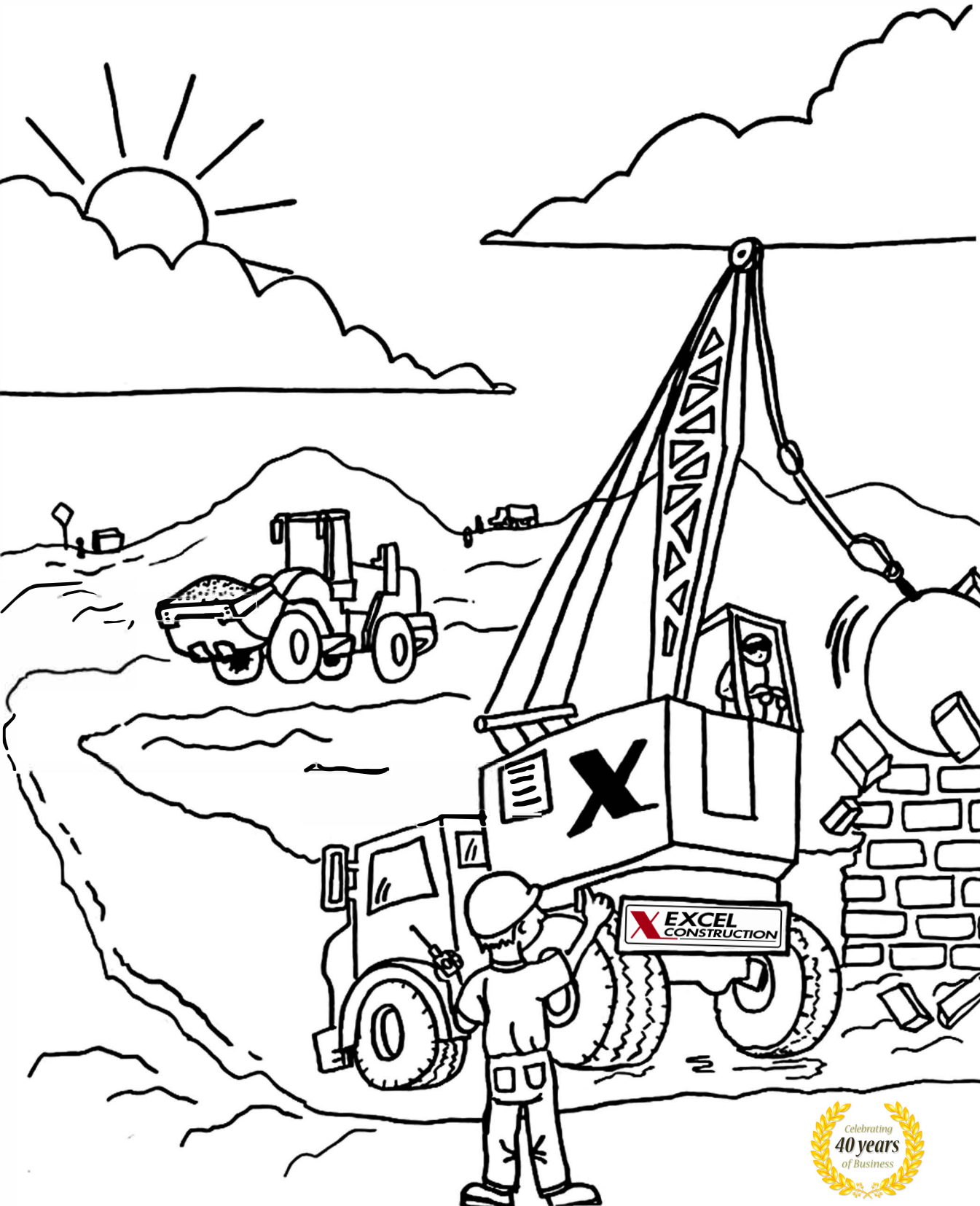

# FIND THE WORD IN THE PUZZLE.

Words can go in any direction.  
Words can share letters as they cross over each other.

S A L A S K A B F C C P C I H  
 P T O U G H D T C O E I G N F  
 M N O I T A I V A J T O G L G  
 U K E S S E V H C C E E A R N  
 P H N P O R T E R B Q R C E I  
 Y O F A O I O A P O U R S M N  
 W T F V P L X T U R I I B O I  
 A T O B U K S E A E P L X T M  
 A U S T I N N R T R M A I E Y  
 H F J S G L E S E S E G R L G  
 Q G R P Q N I V U N N N E T A  
 F U C B A Z R G N Z T V E R S  
 D W Z L A X A F R V A A V G R  
 M A N U F A C T U R E M L V Q  
 N P H T R O N E G A G O G S I

ALASKA	ARCTIC
AUSTIN	AVIATION
ESI	GAS
GRAVELY	HEATERS
KUBOTA	MANUFACTURE
NORTH	OIL
PUMPS	SNOW
RURAL	RENTALS
TOUGH	PARTS
SLOPE	MINING
REMOTE	JCB
GENERATORS	ARIENS
EQUIPMENT	

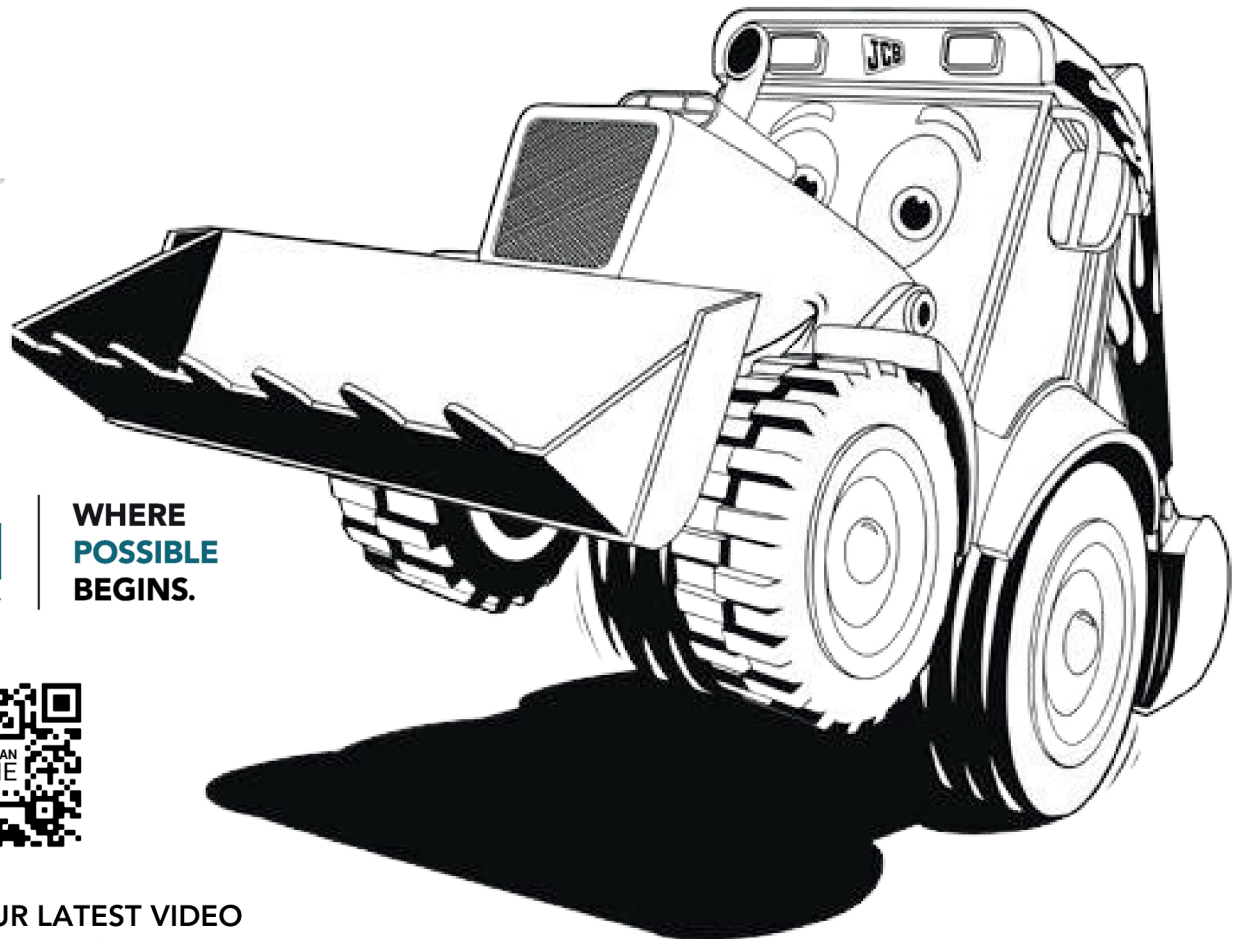

WHERE  
POSSIBLE  
BEGINS.



CHECK OUT OUR LATEST VIDEO

# HOW TO MAKE CONCRETE

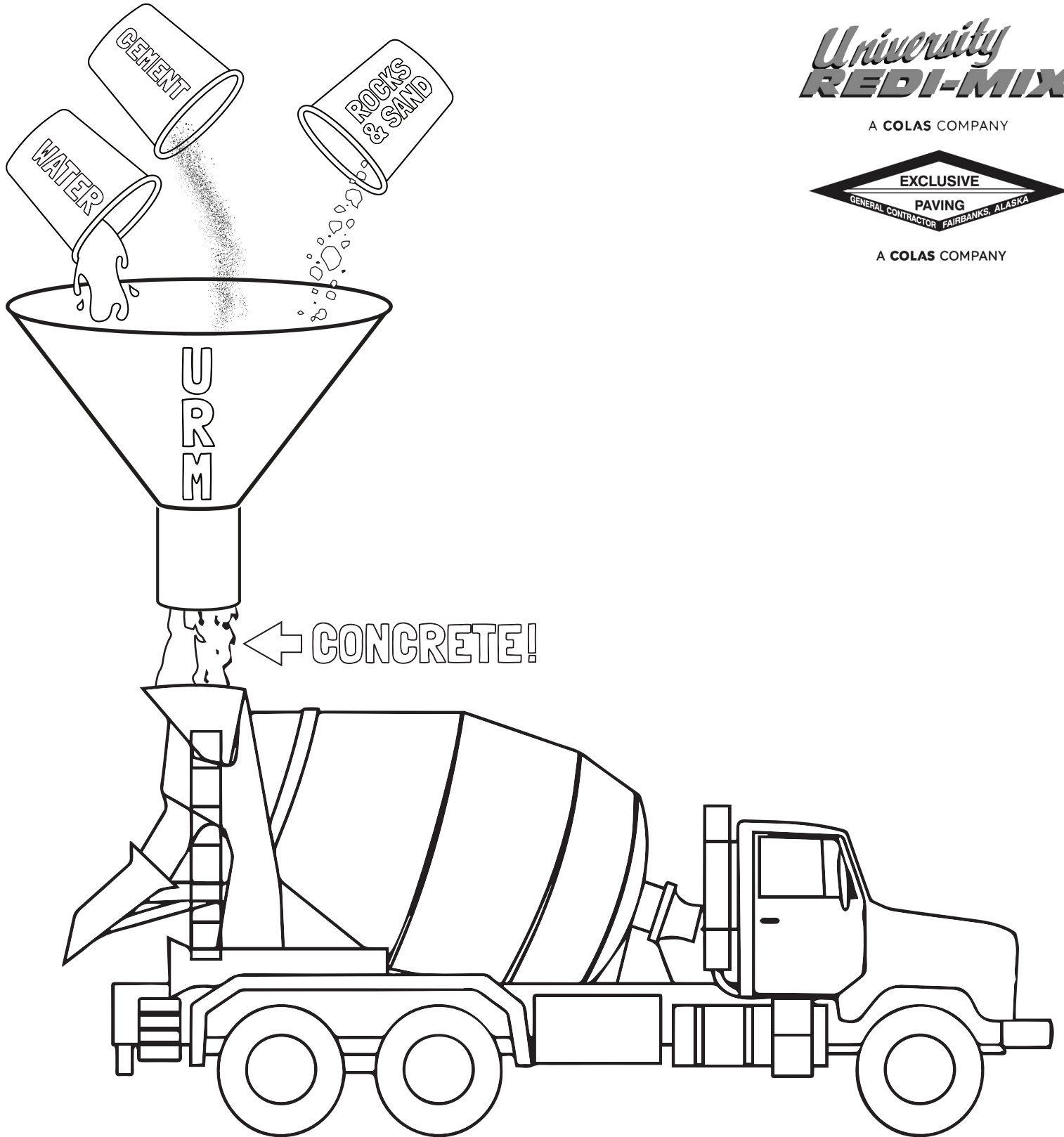

*University*  
**REDI-MIX**

A COLAS COMPANY



A COLAS COMPANY

## CONCRETE IS USED FOR:

CURBS

GUTTERS

SIDEWALKS

PARKING LOT BUMPERS

FOUNDATIONS

PLUG IN POLES

BRIDGES

WALLS

Circle all of these that you have seen near your home.



# F&W Construction Company Inc.

Can you find the differences?

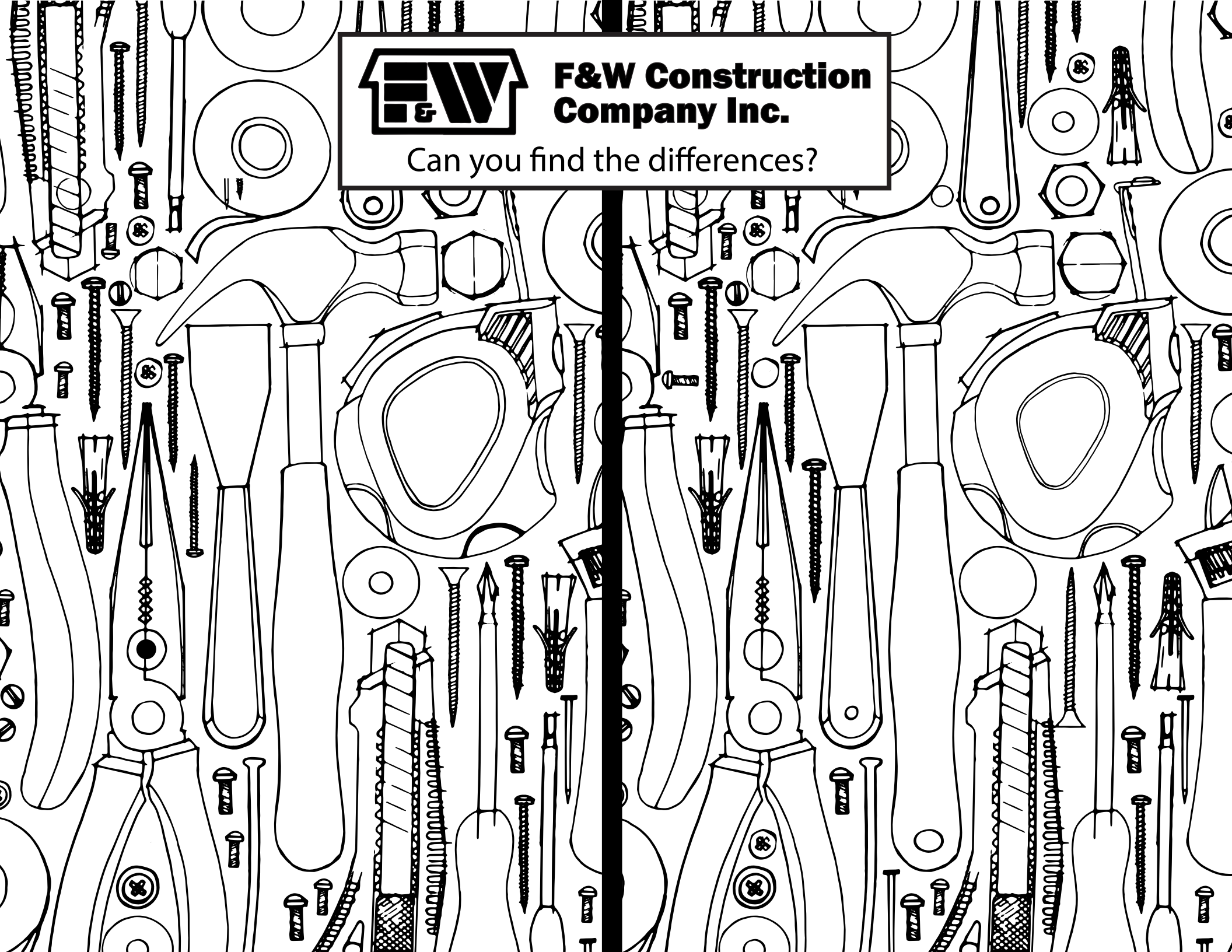

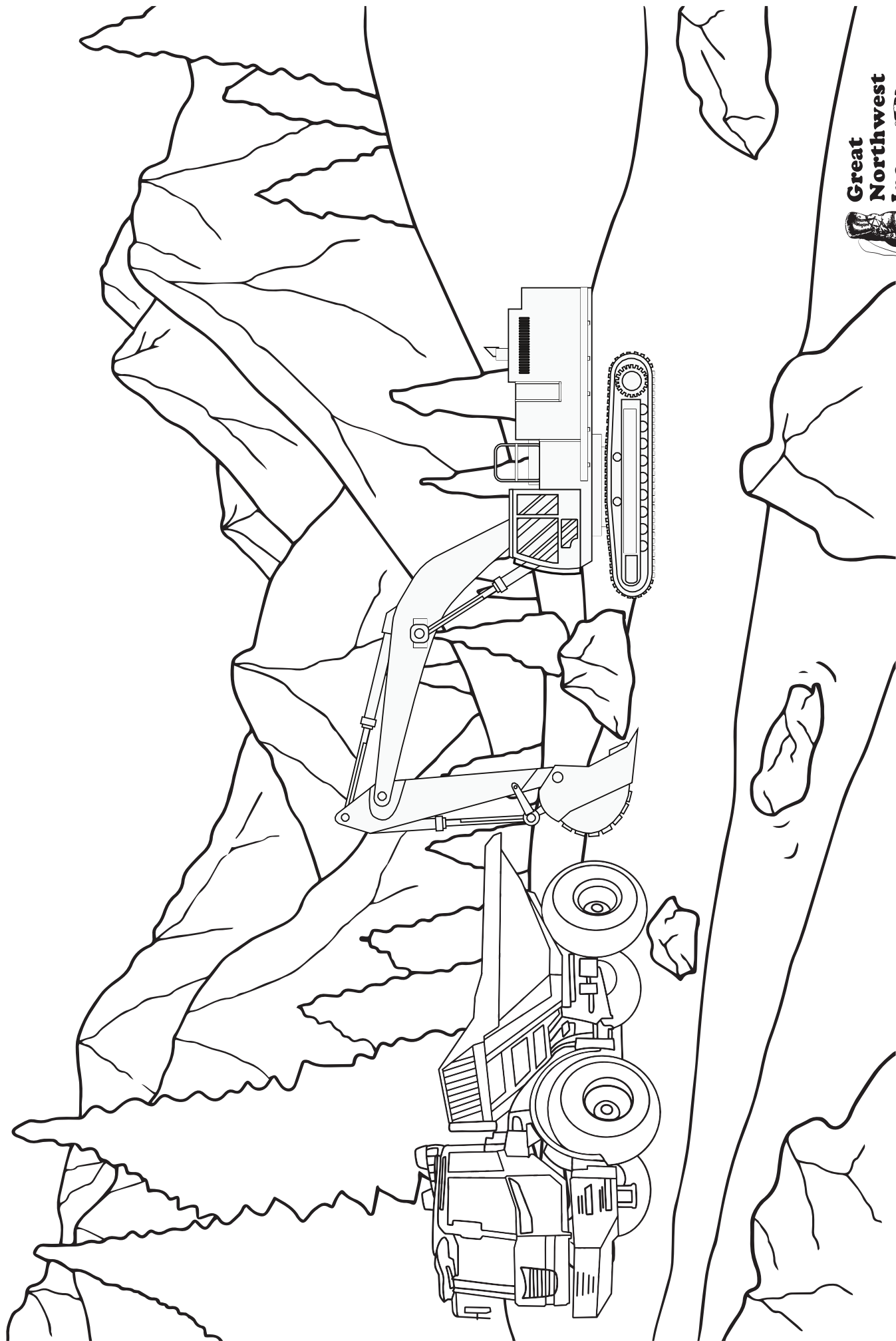

**Great  
Northwest  
Inc.**





# KNIK CONSTRUCTION

S J L Y Y V F X K I B E F B I  
 A K E H T B H C C D U J T M M  
 F P J A G A Z C N C V O A N D  
 E J L R O S I B N R E B O J D  
 T X W D T E I F X G P I I O P  
 Y Y C H W V D U R C T C B M B  
 C N J A R C U L K C Z W T W A  
 A S I T V A M X U F I U O J D  
 T X Z H D A P R C X X H T F O  
 F C X N U I T R C J K S G E J  
 A C D X J S R O L Z H I S Y Q  
 L H A O N T U T R N V D L C V  
 E I C O Y H C R A A K F T A U  
 Z E C O C V K R W U T H V T V  
 Y H L C J X B C J D U C A I S

CONSTRUCTION

DIRT

DUMP TRUCK

EXCAVATOR

HARD HAT

SAFETY

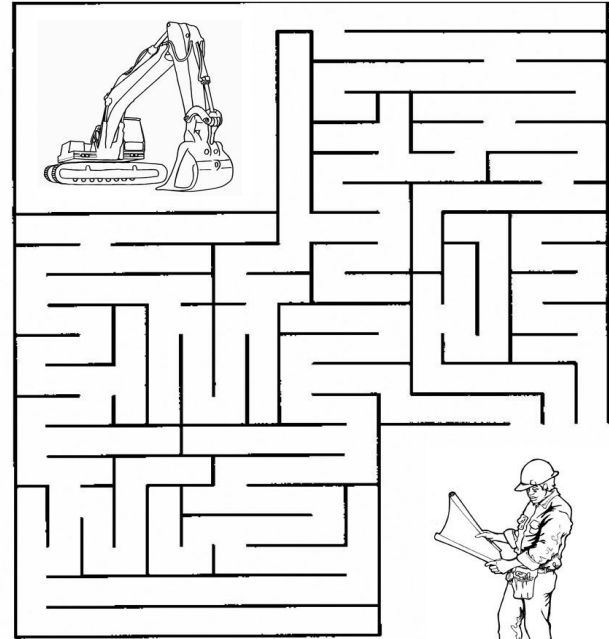

Dan is lost. Help him find his equipment!

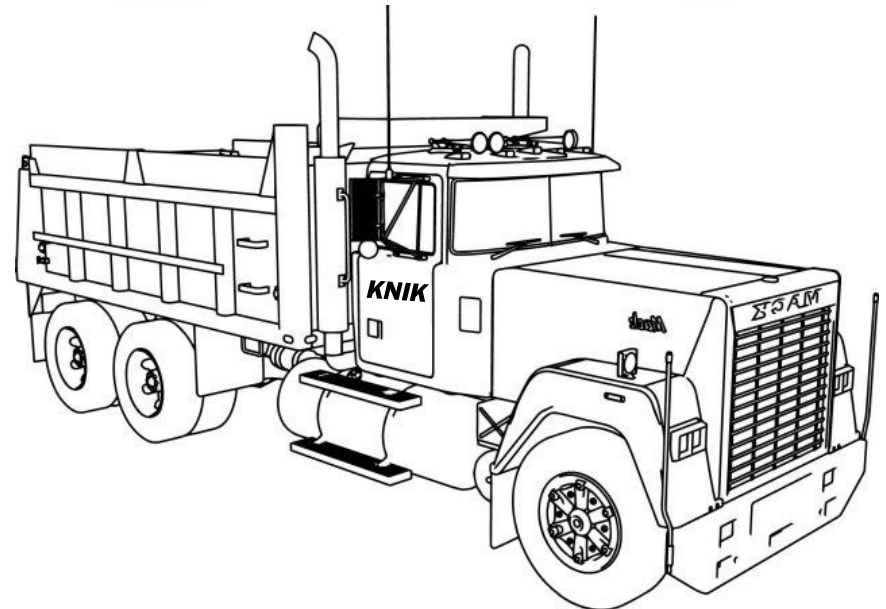
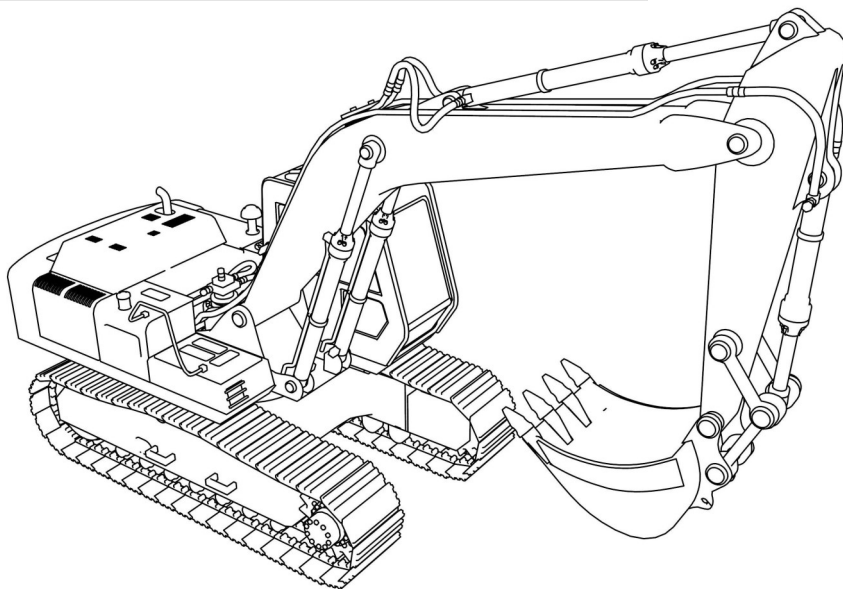

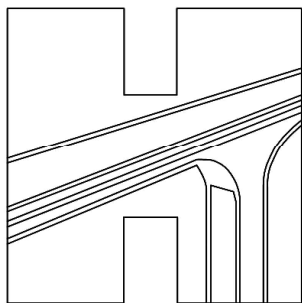
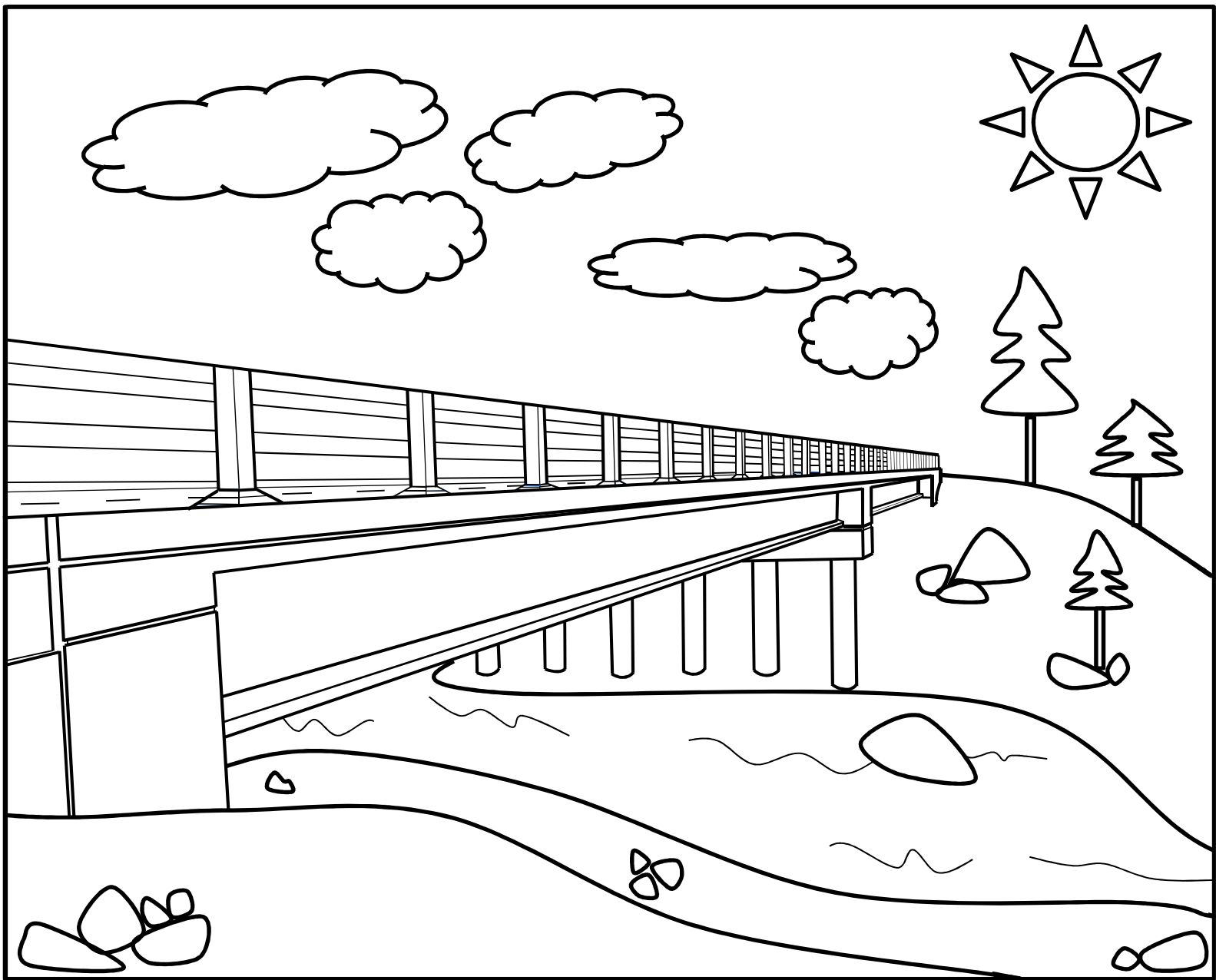

**HAMILTON**  
CONSTRUCTION  
ALASKA

CONTRACTORS & ENGINEERS

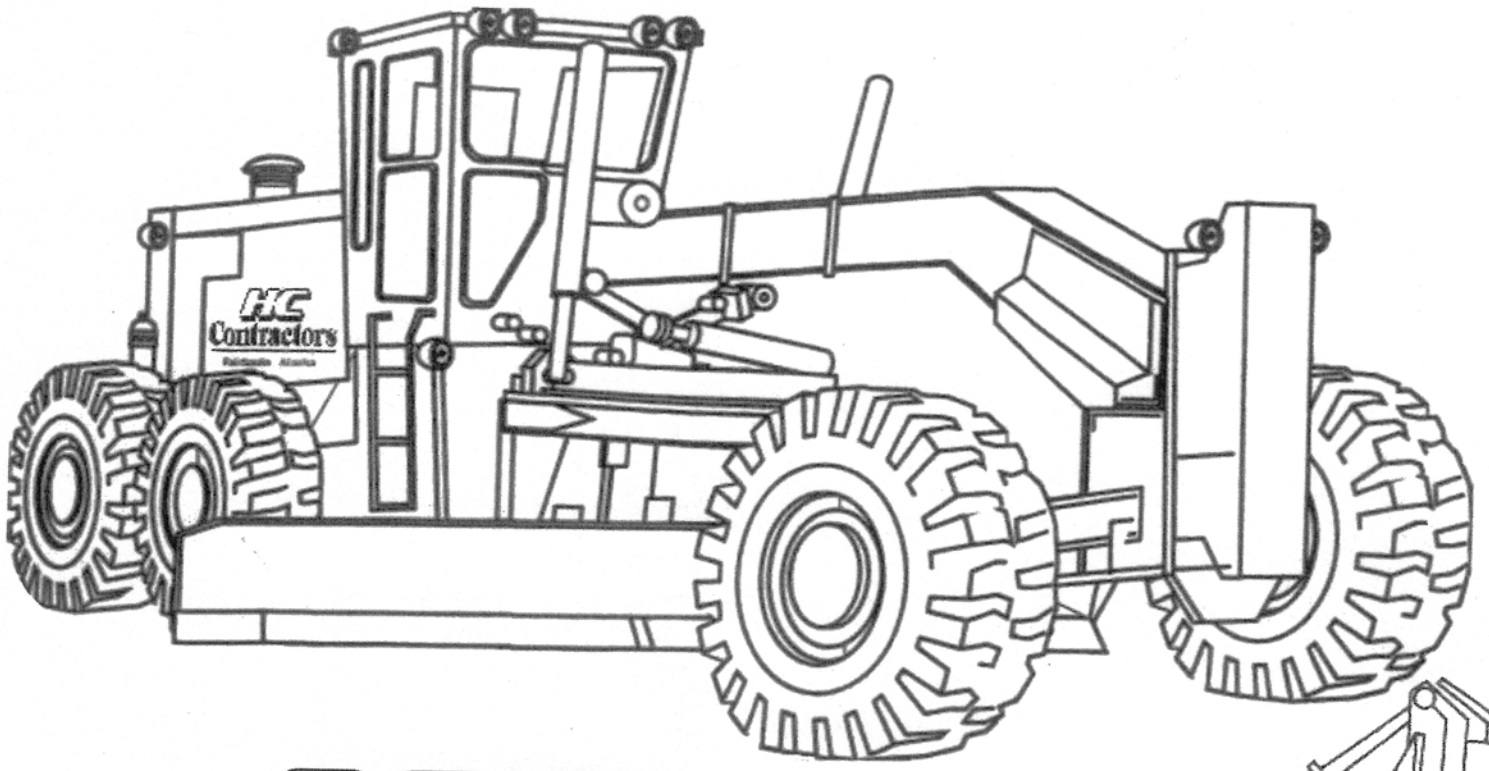

# **HC** **Contractors**

---

**FAIRBANKS • ALASKA**

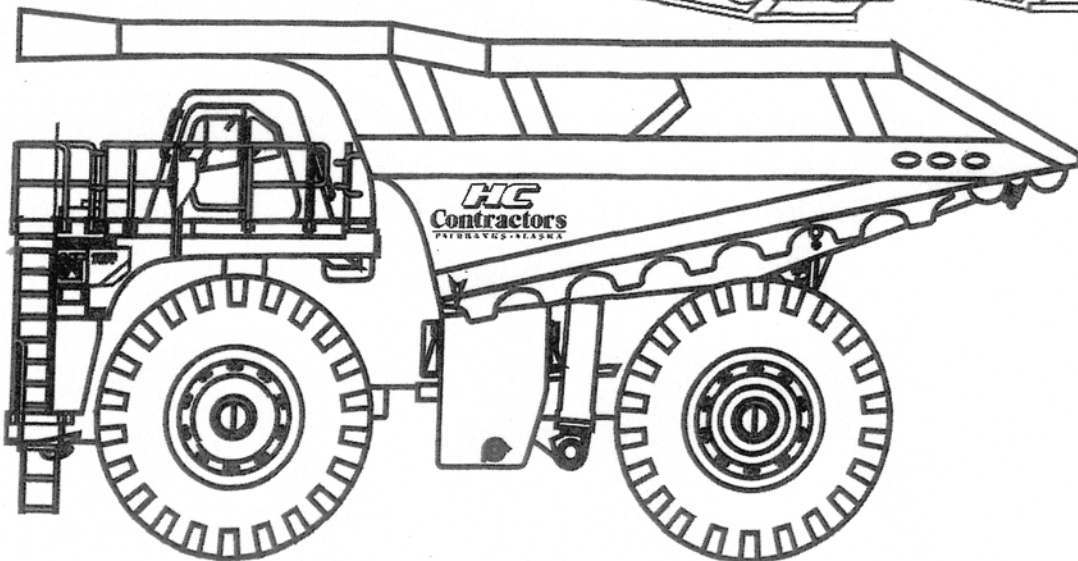
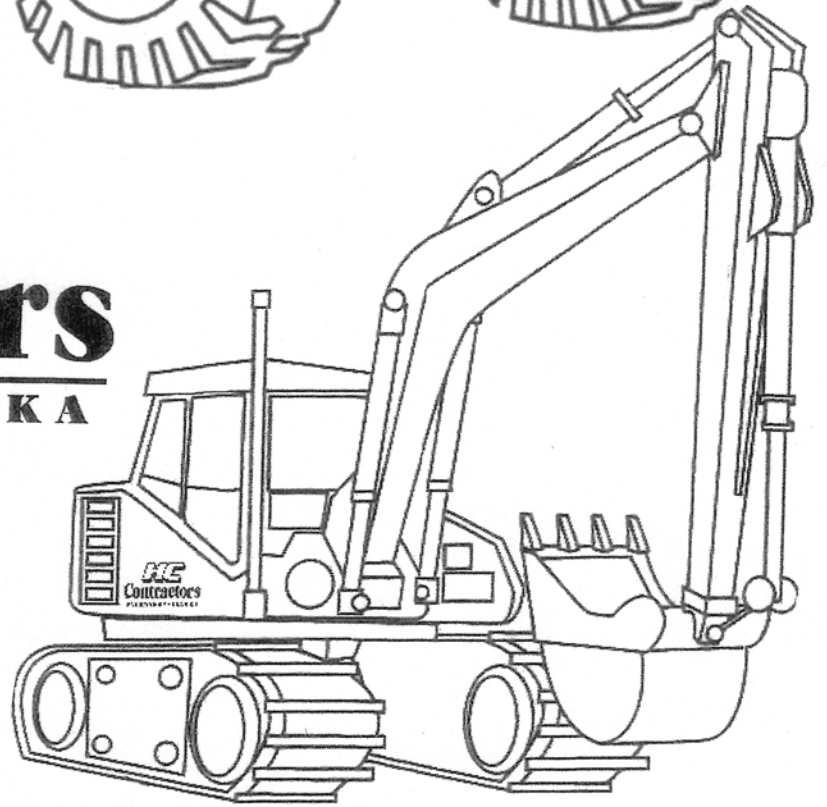



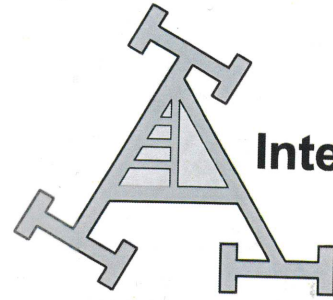

**Interior Alaska  
Roofing, Inc.**

***"Nothing beats A TEAM"***  
**2023**

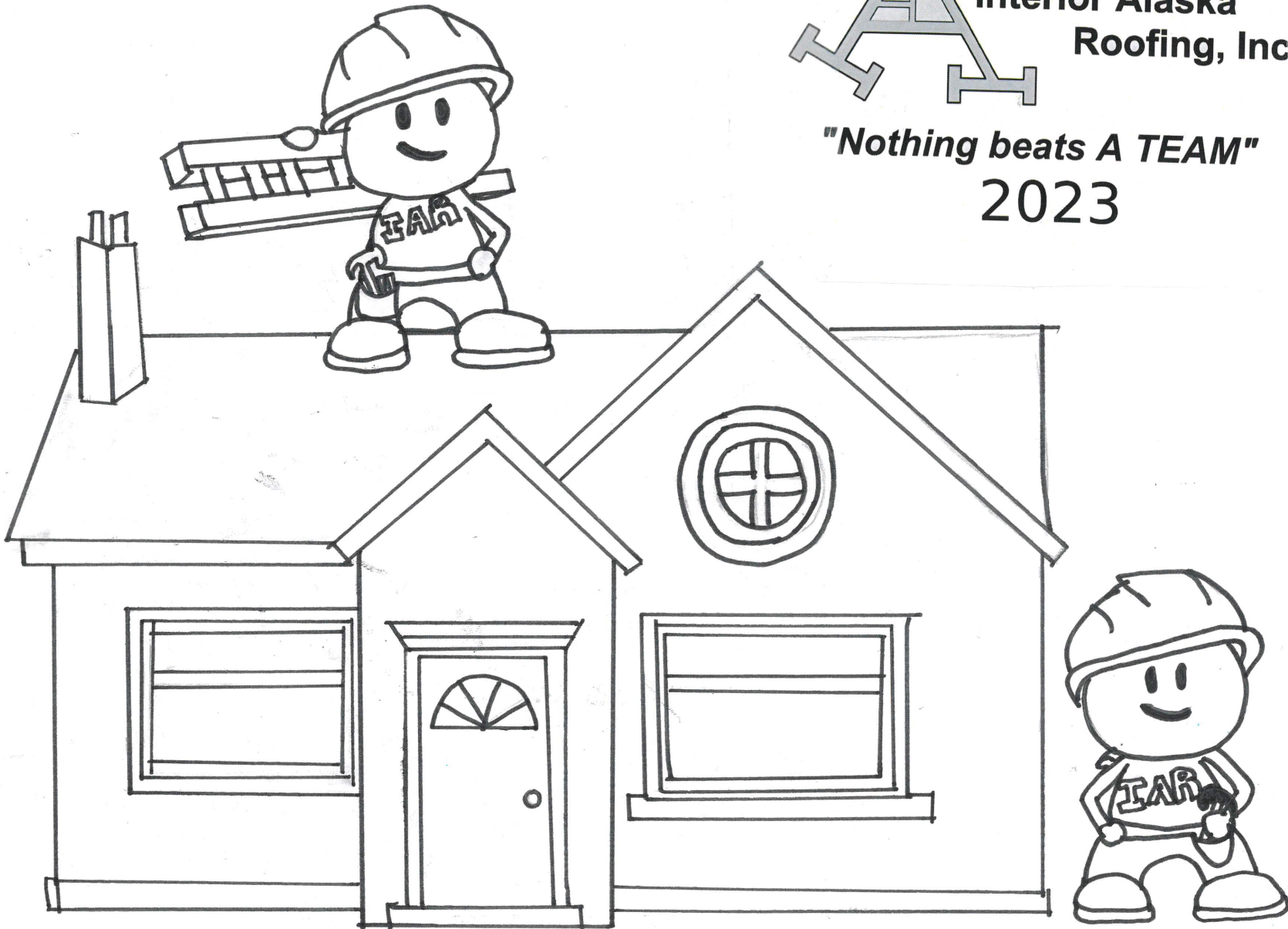

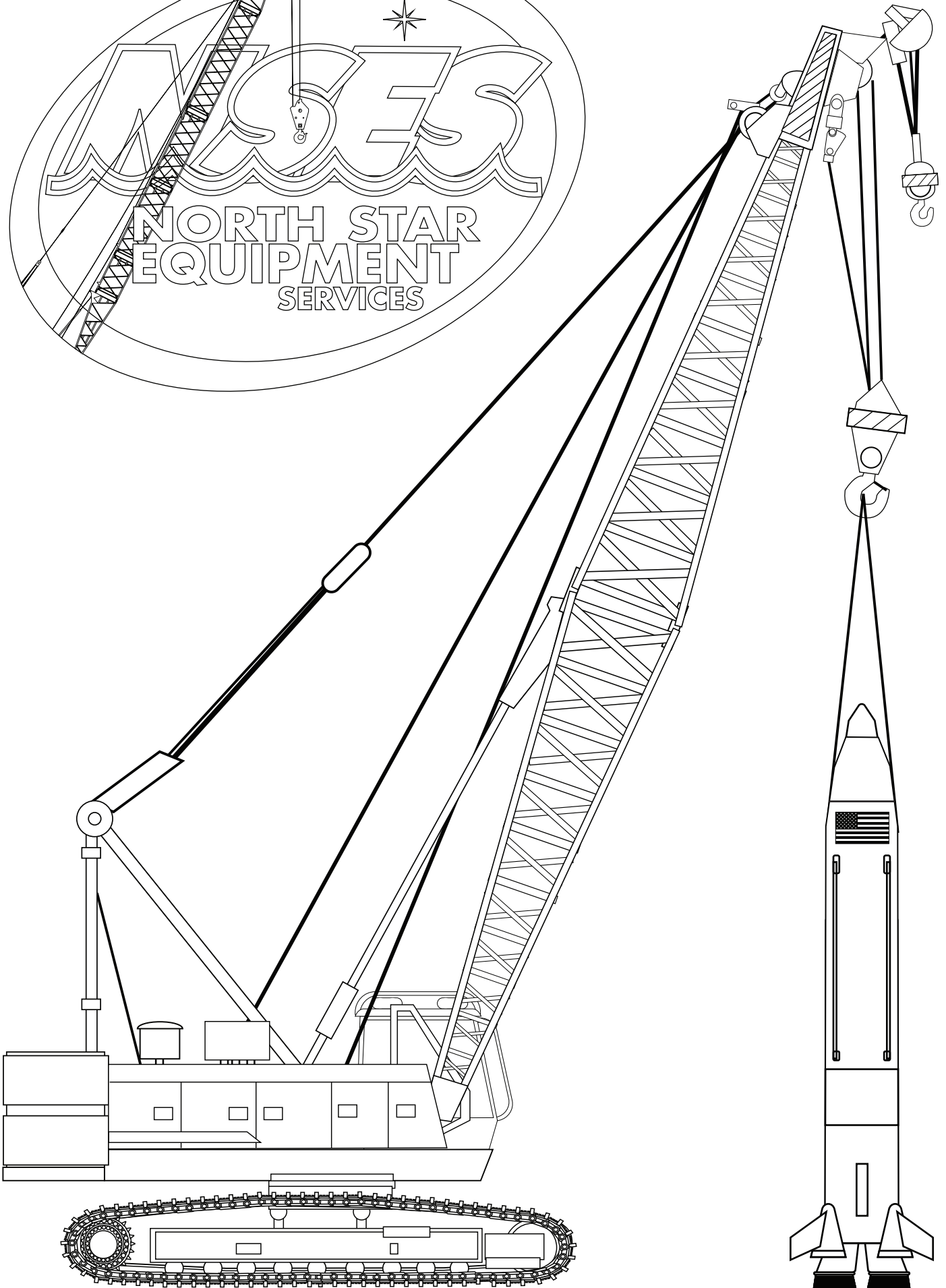
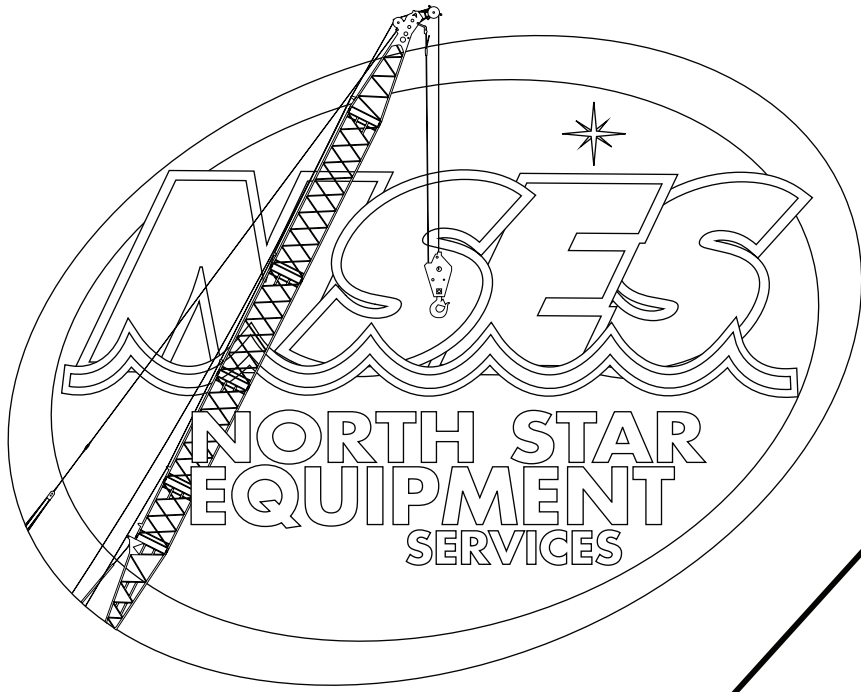

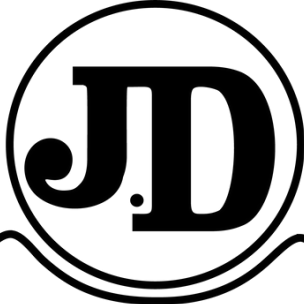

**STEEL CO., INC.**

*An Employee Owned Company*

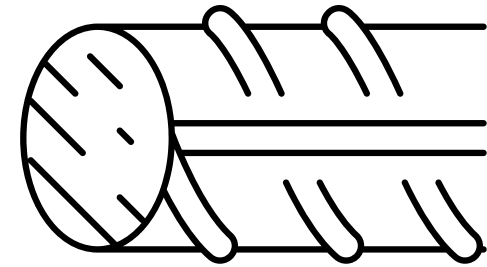
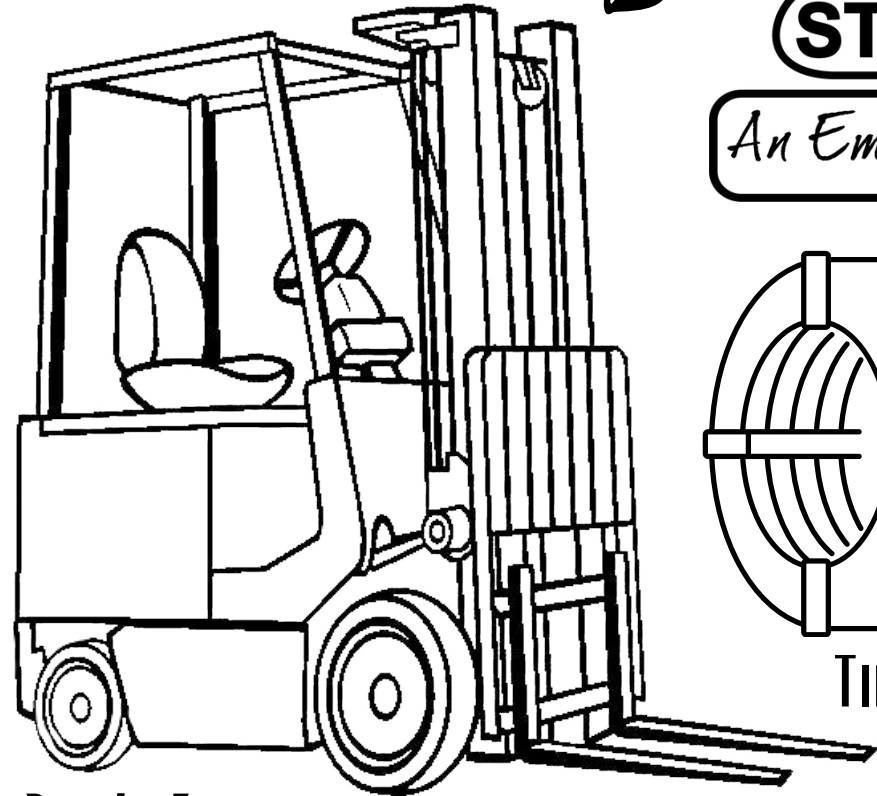

REBAR

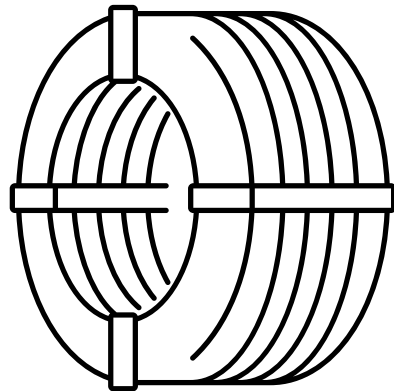

TIE WIRE

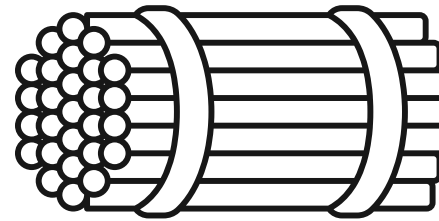

BUNDLED REBAR

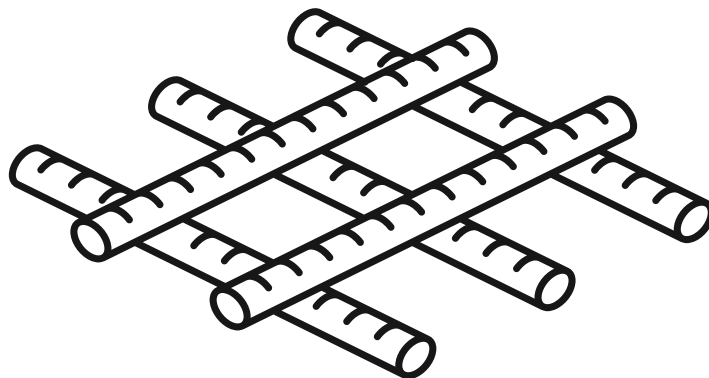
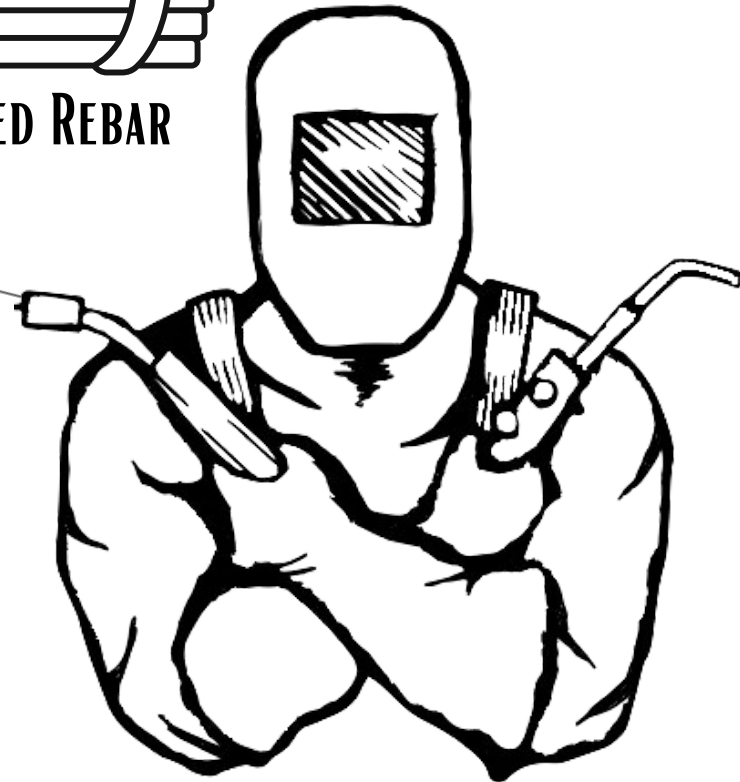
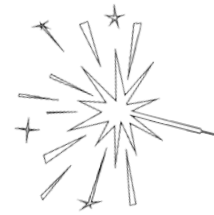

TIED CAGE

DON'T FORGET

HANK!

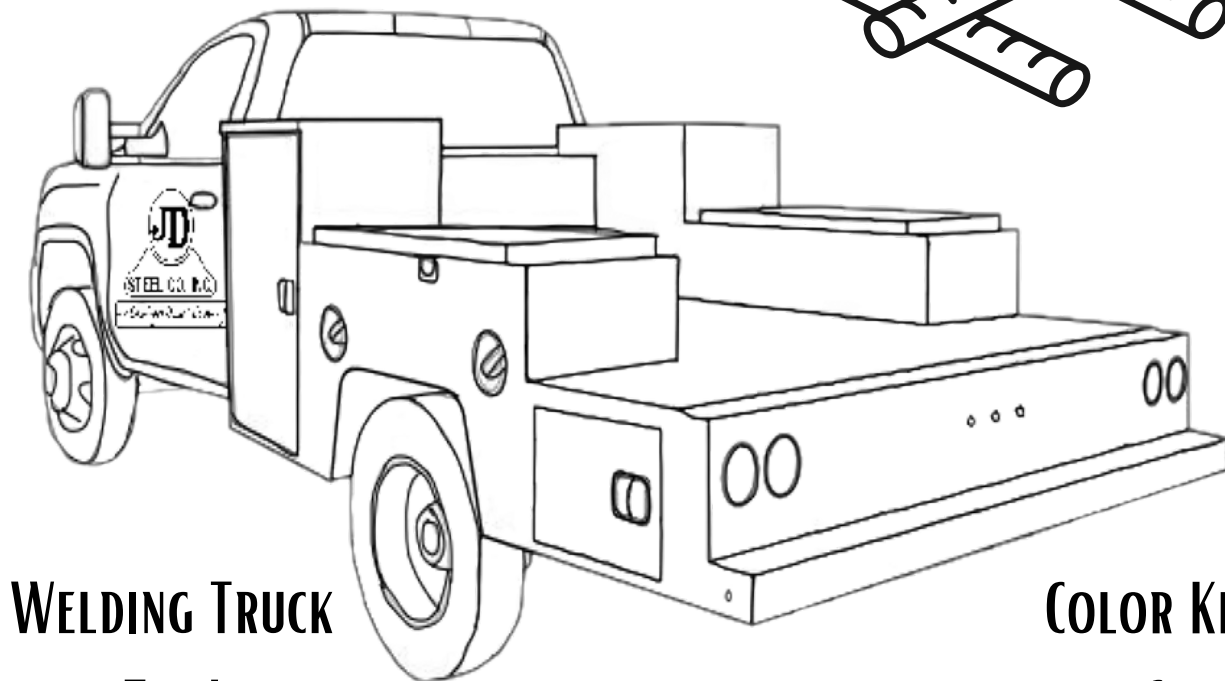

WELDING TRUCK

Too!

COLOR KEITH'S

CART!



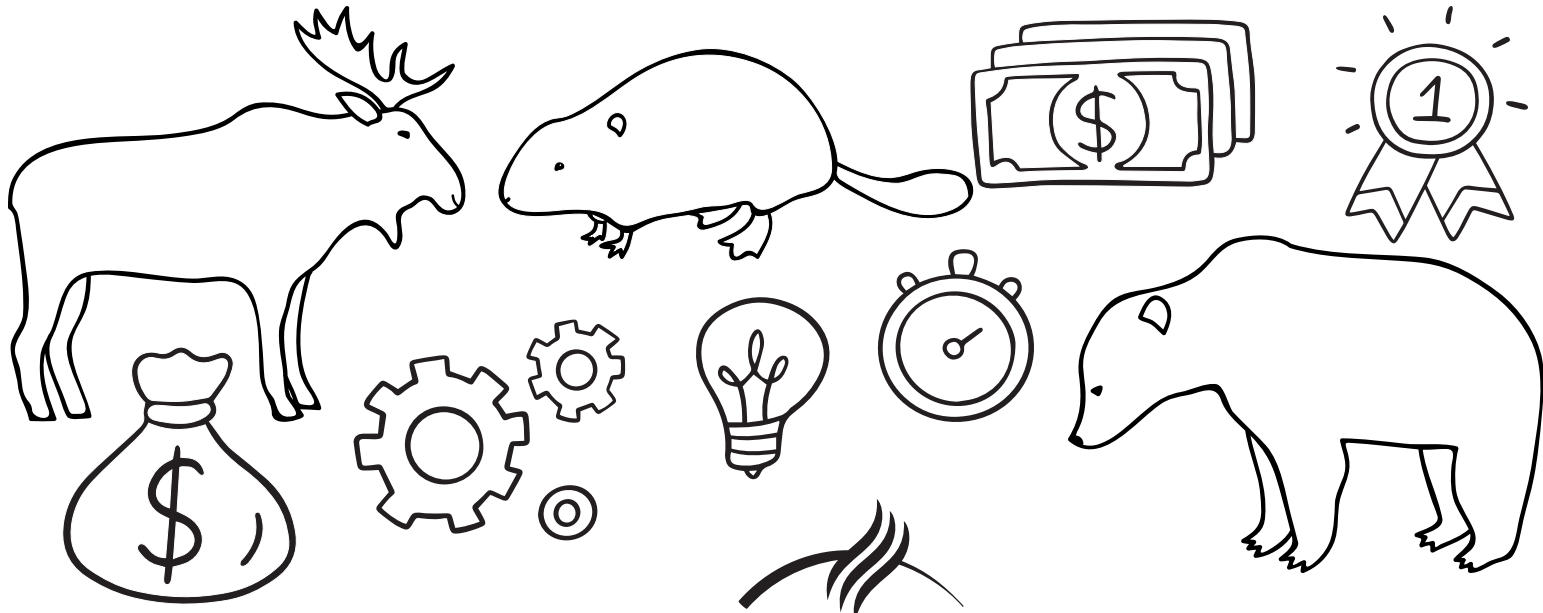

# Northrim Bank<sup>®</sup>

A	G	W	D	A	A	I	A	A	D	B	B	A	A
C	L	I	E	R	N	K	C	A	B	A	D	E	C
U	E	T	D	O	A	C	R	A	H	L	E	G	R
S	N	H	A	R	W	C	N	M	I	A	Y	A	A
T	O	D	M	A	A	K	T	N	R	N	I	N	D
O	T	R	N	A	E	W	T	I	R	C	L	S	E
M	E	A	I	R	C	G	E	L	D	E	A	C	P
E	S	W	O	L	G	W	I	R	U	E	R	H	O
R	S	A	C	S	G	N	I	V	A	S	R	E	S
A	E	L	A	C	C	O	U	N	T	D	S	C	I
R	A	T	N	E	M	Y	A	P	E	E	M	K	T
C	S	T	A	R	M	A	N	A	G	E	R	I	S
E	A	E	O	R	T	E	L	L	E	R	P	N	A
S	M	O	N	E	Y	M	A	R	K	E	T	G	S



- CREDIT CARD
- CHECKING
- DEPOSIT
- WITHDRAWAL
- DRAWER
- PAYMENT
- SAVINGS
- CUSTOMER
- ACCOUNT
- MONEY MARKET
- BALANCE
- NOTES
- BANER
- TELLER
- MANAGER
- COIN

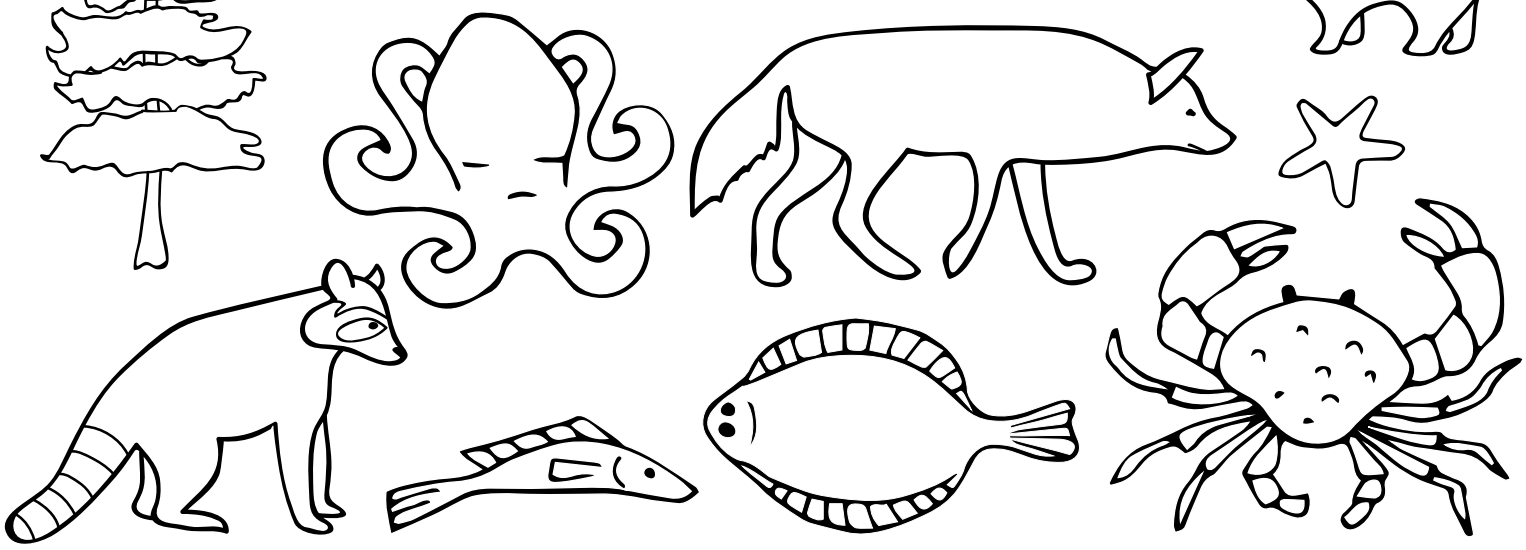

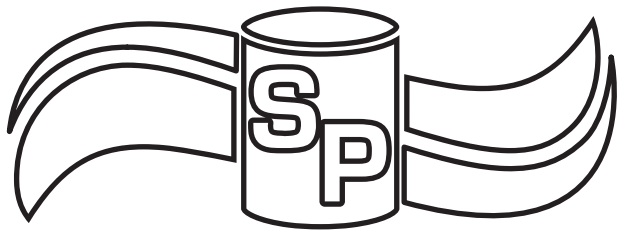

# SHORESIDE PETROLEUM

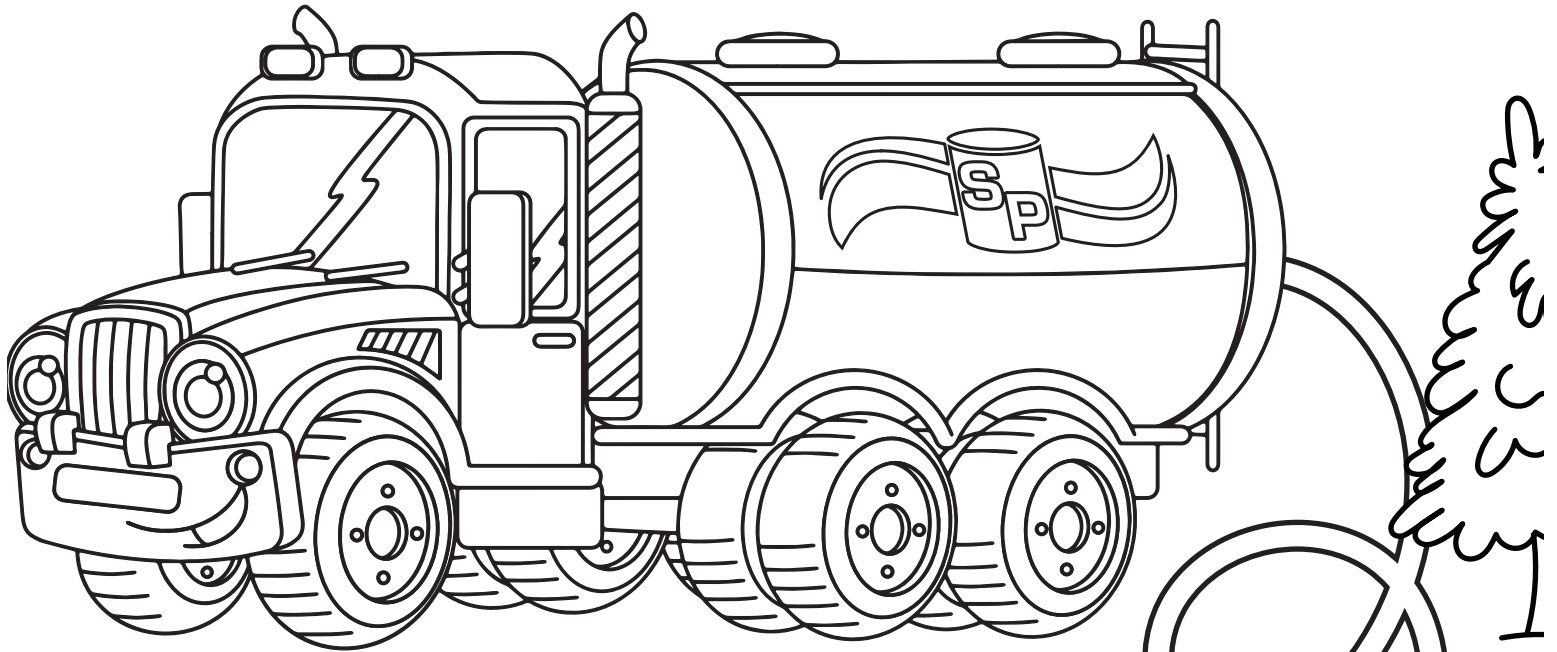

Copyright © 2001  
Shoreside Petroleum

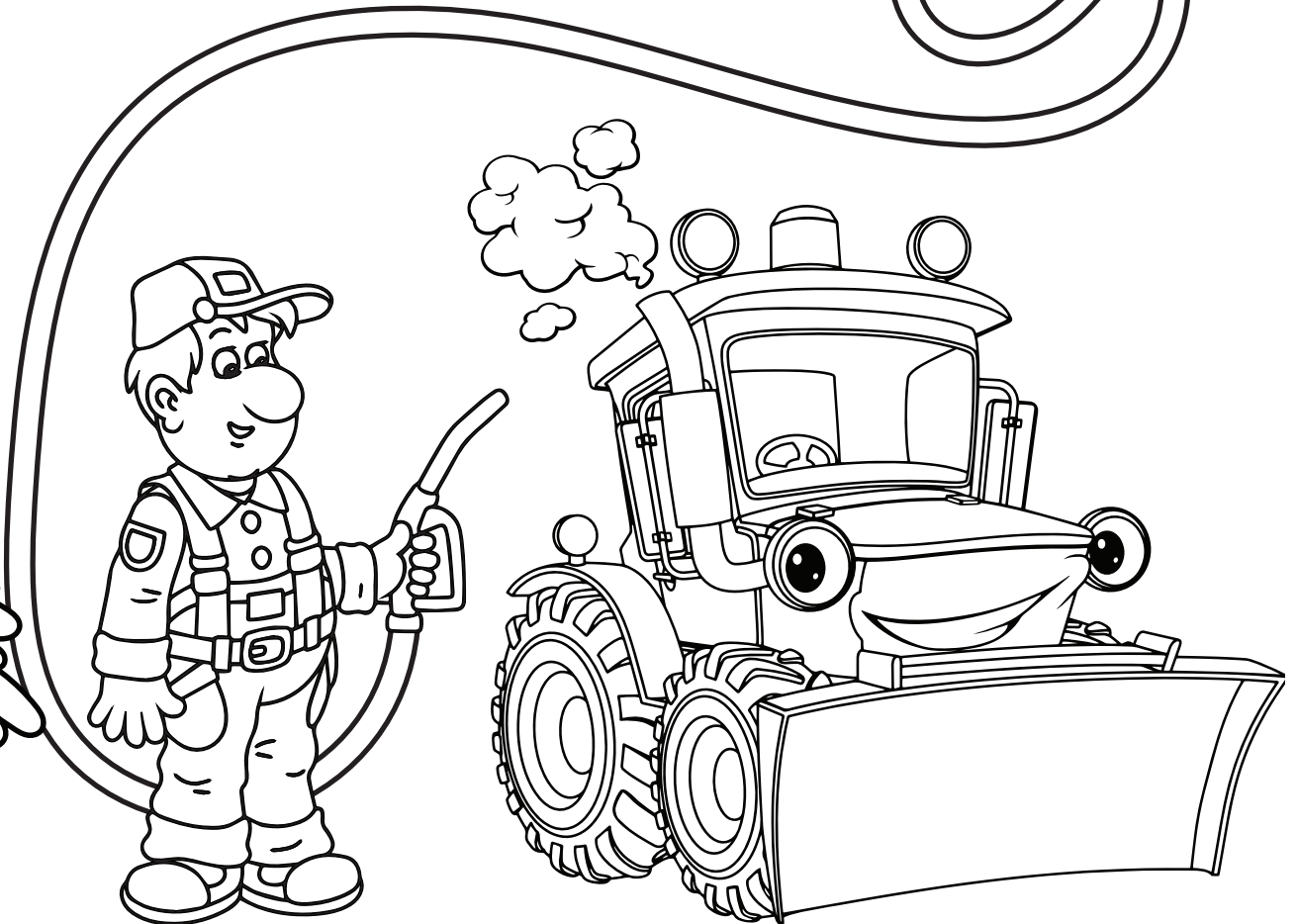



**IUPAT  
ALASKA  
LOCAL  
1959,**

**REPRESENTING:**

**PAINTERS**

**GLAZIERS**

**FLOOR COVERERS**

**DRYWALL FINISHERS**

**SIGN & DISPLAY WORKERS**

# LYNDEN

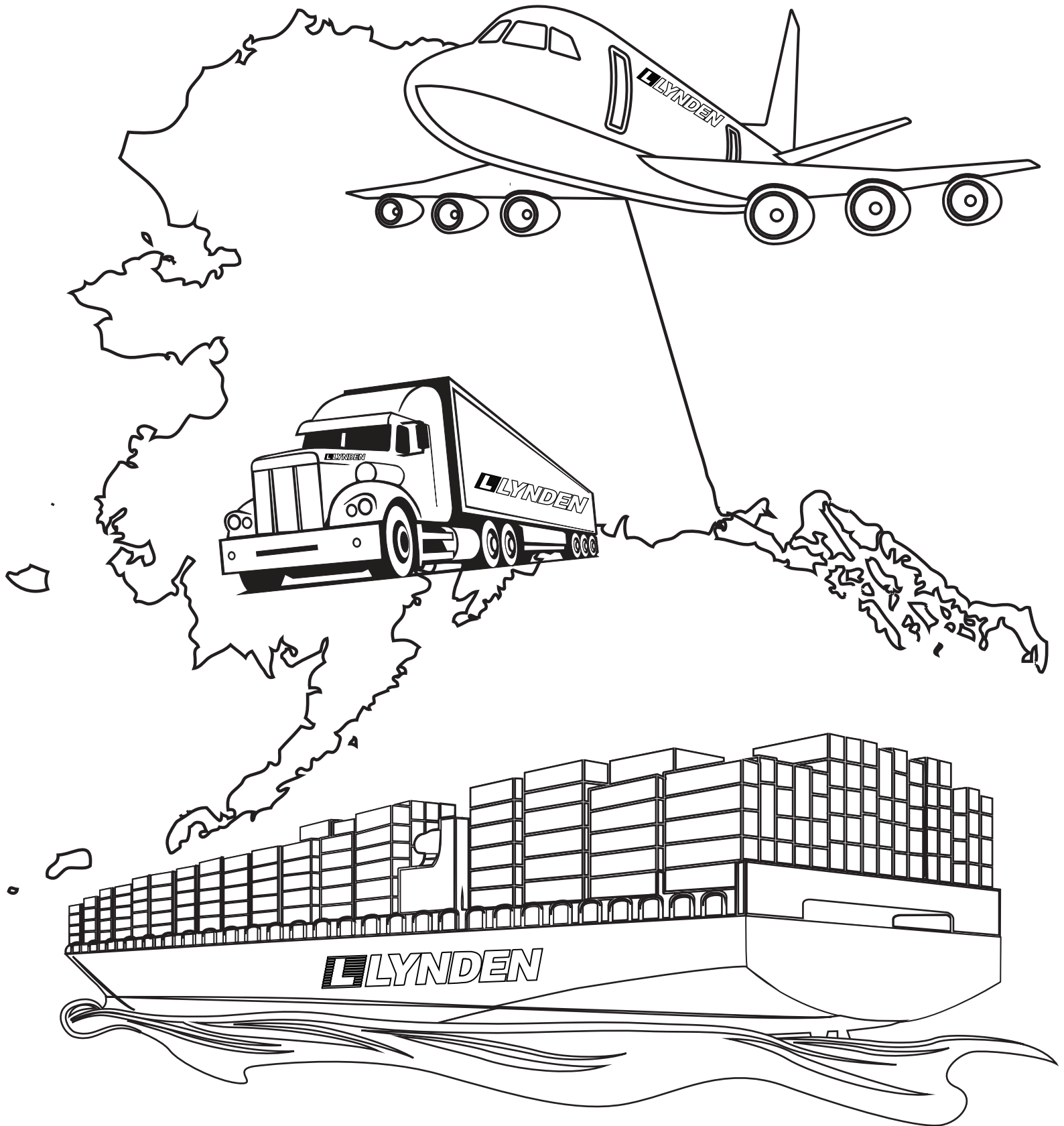

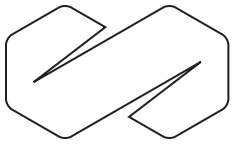

Marsh McLennan  
Agency

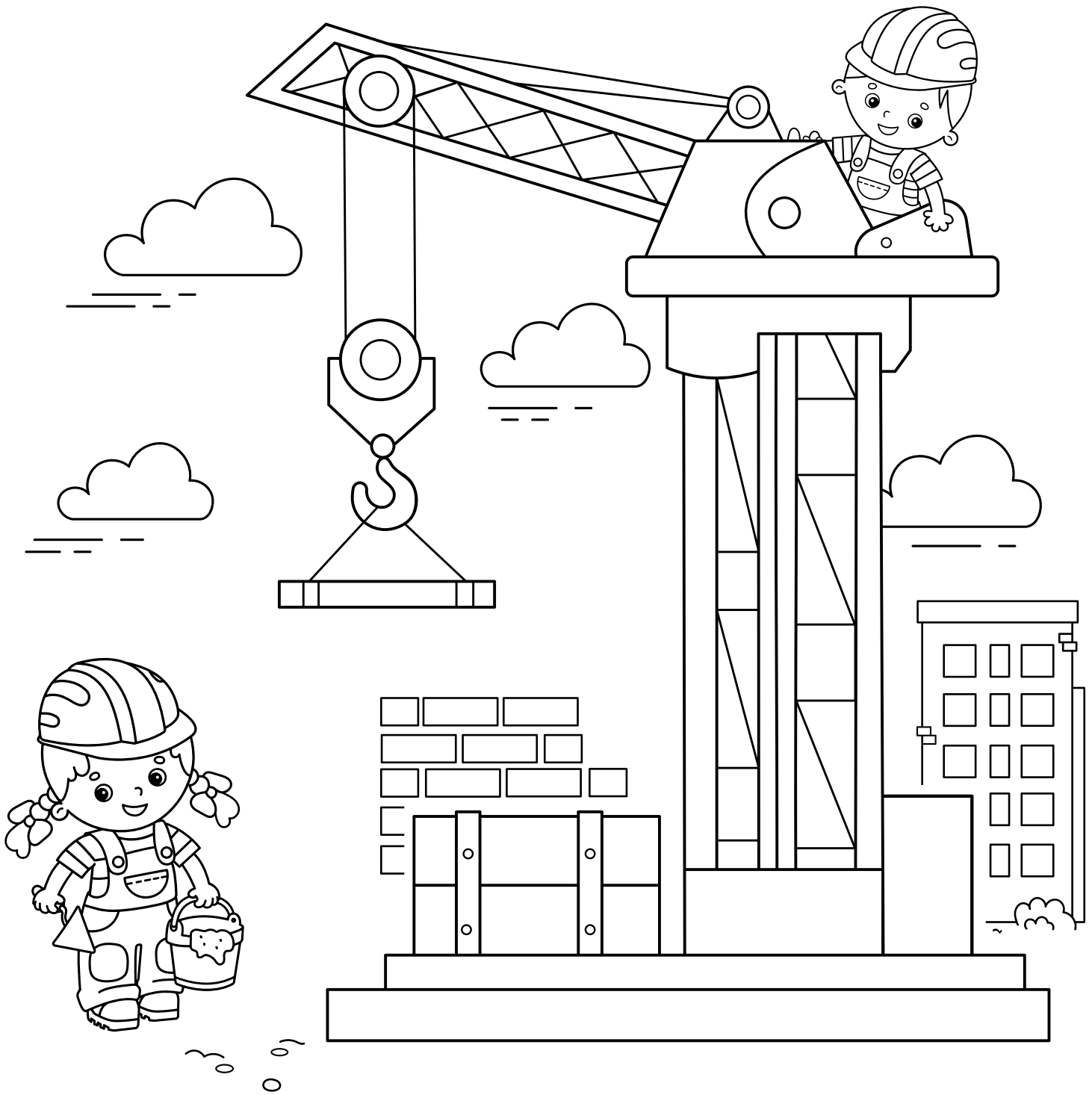

Your future is limitless.<sup>SM</sup>



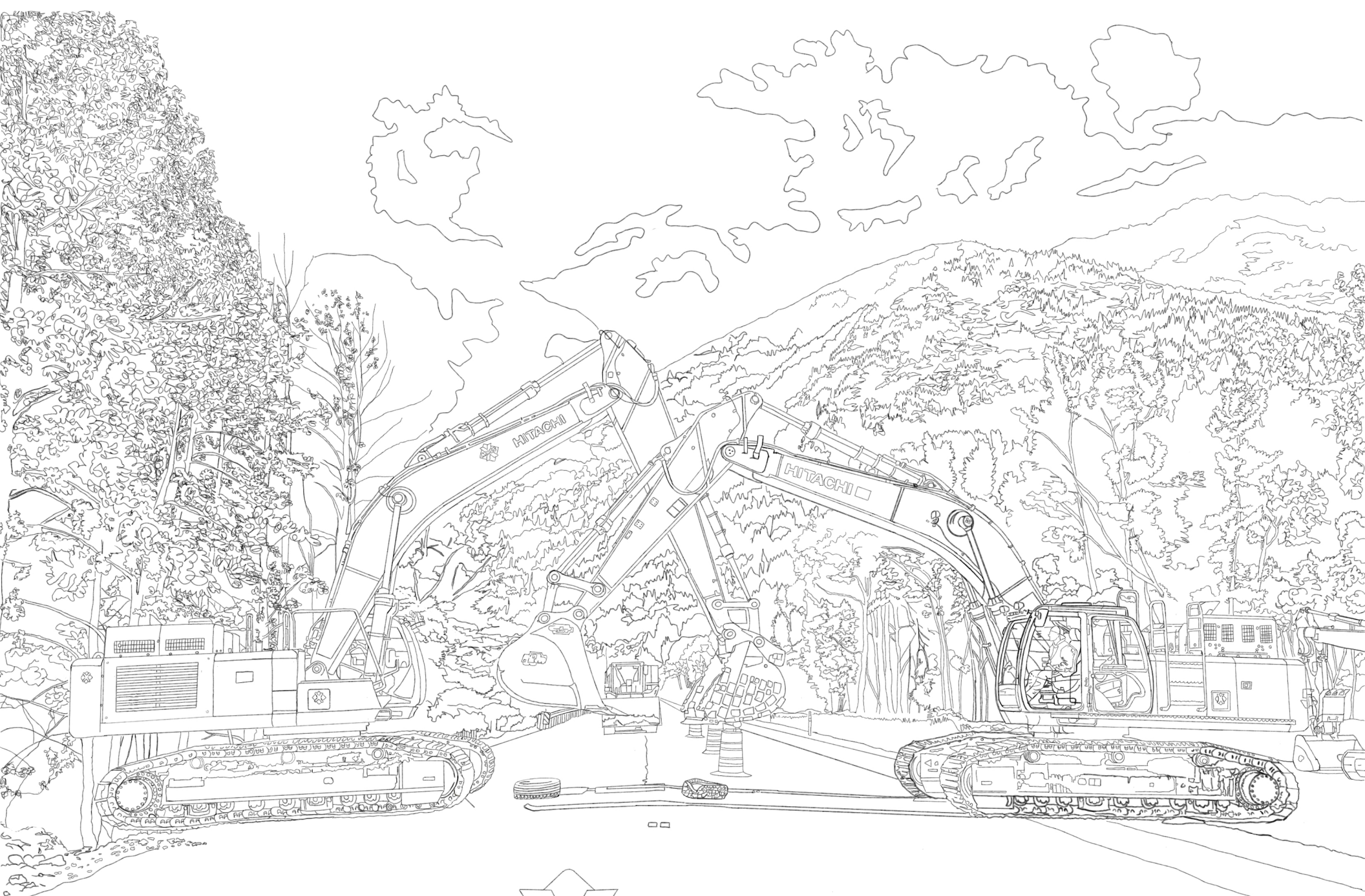

**MASS**

**EXCAVATION, INC.**



**PETRO  
MARINE**

**PETRO  
MARINE**

Submarine

**Help the dump truck pick up the  
GRAVEL load, then get to the  
FINISH to help the customer.**



**FINISH**



**START**



**PFK**

**enterprises**

Philomena King

907-322-2247

ANC 8(a)

STG  
PACIFIC

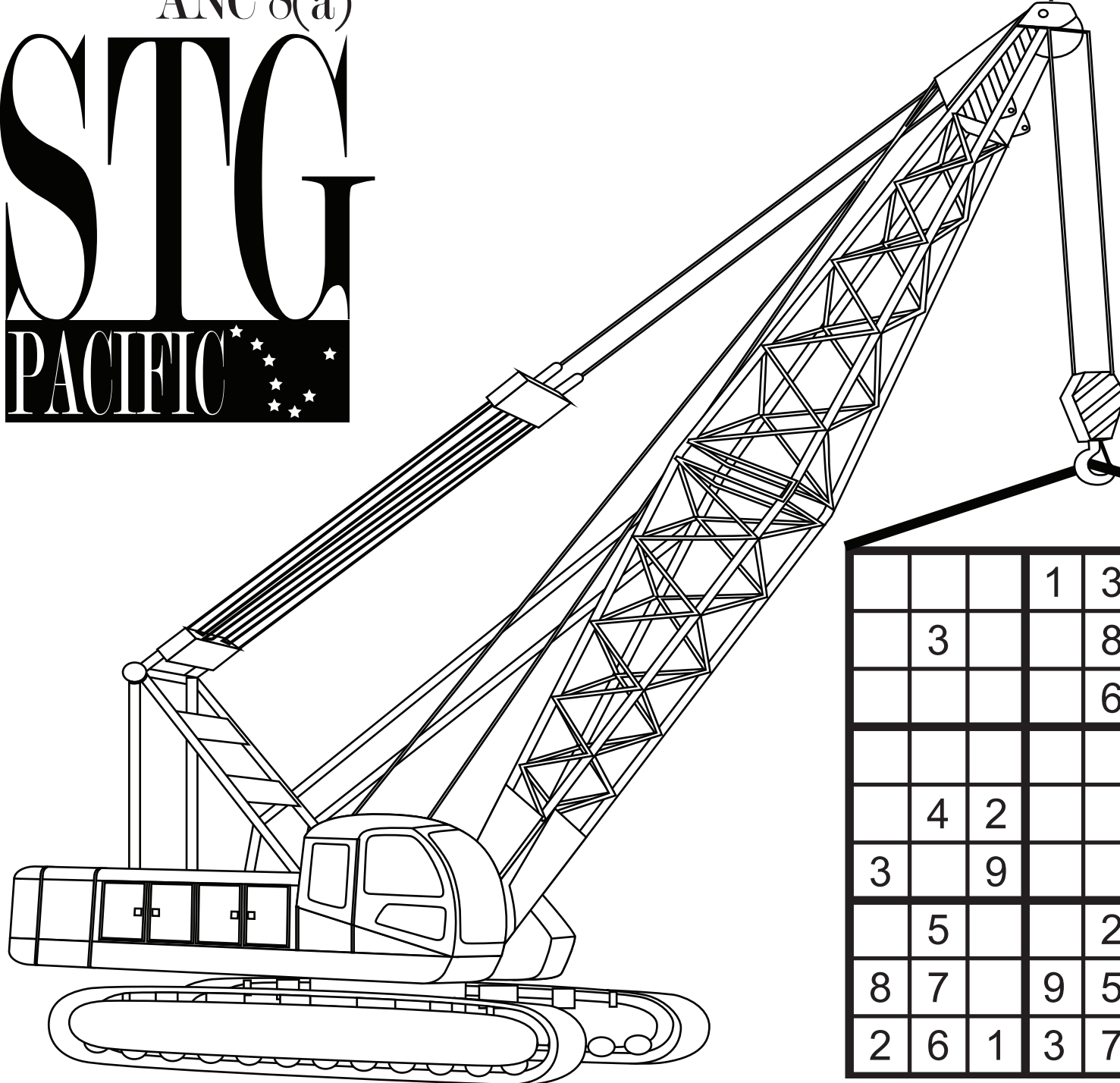

			1	3	2	6	8	7
	3			8	7		9	4
				6			3	
						8		9
	4	2				1	7	
3		9						
	5			2				
8	7		9	5			6	
2	6	1	3	7	8			

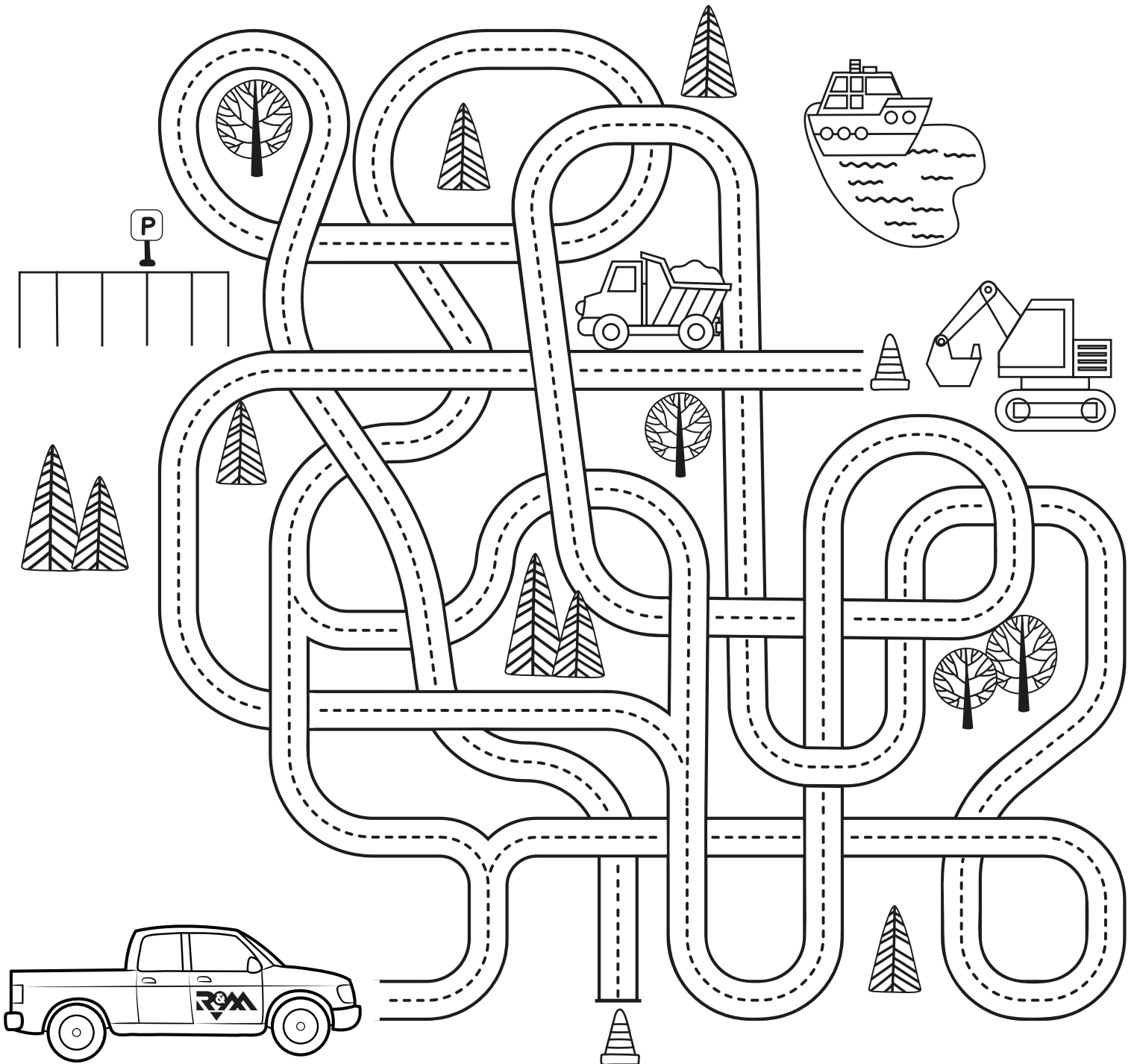
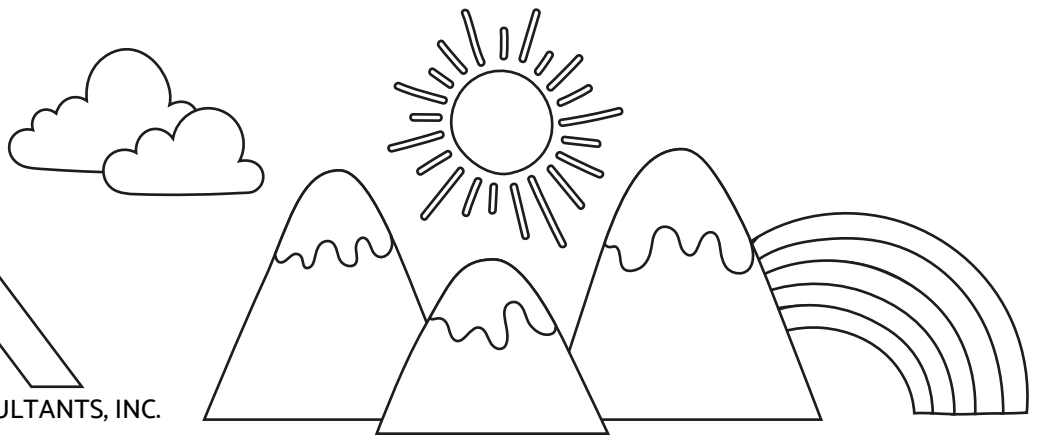

# Rain Proof Roofing

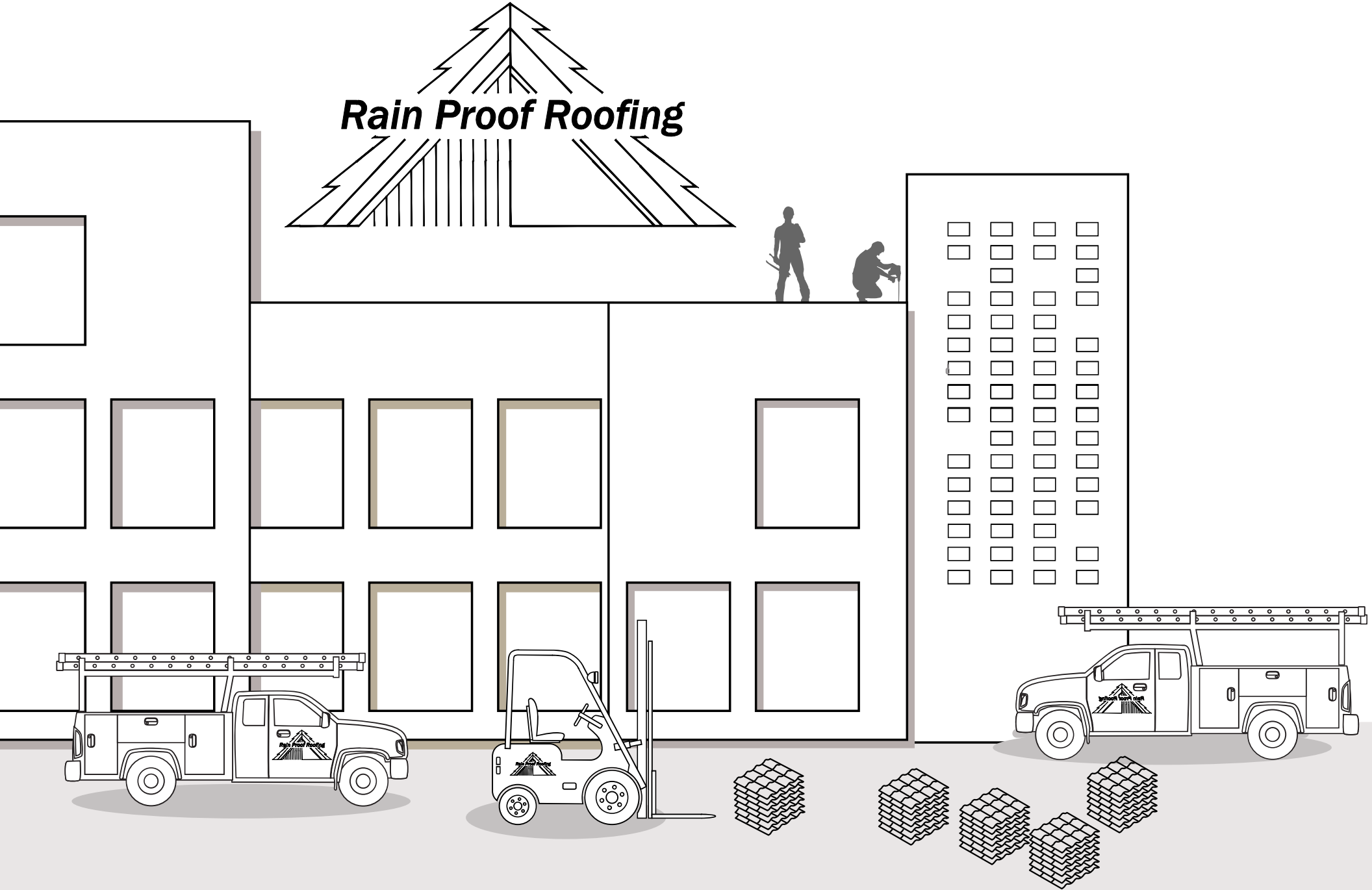

**RHC** | **ROGER HICKEL  
CONTRACTING**





spenard builders supply

# BUILDING

F O R T H E

# FUTURE

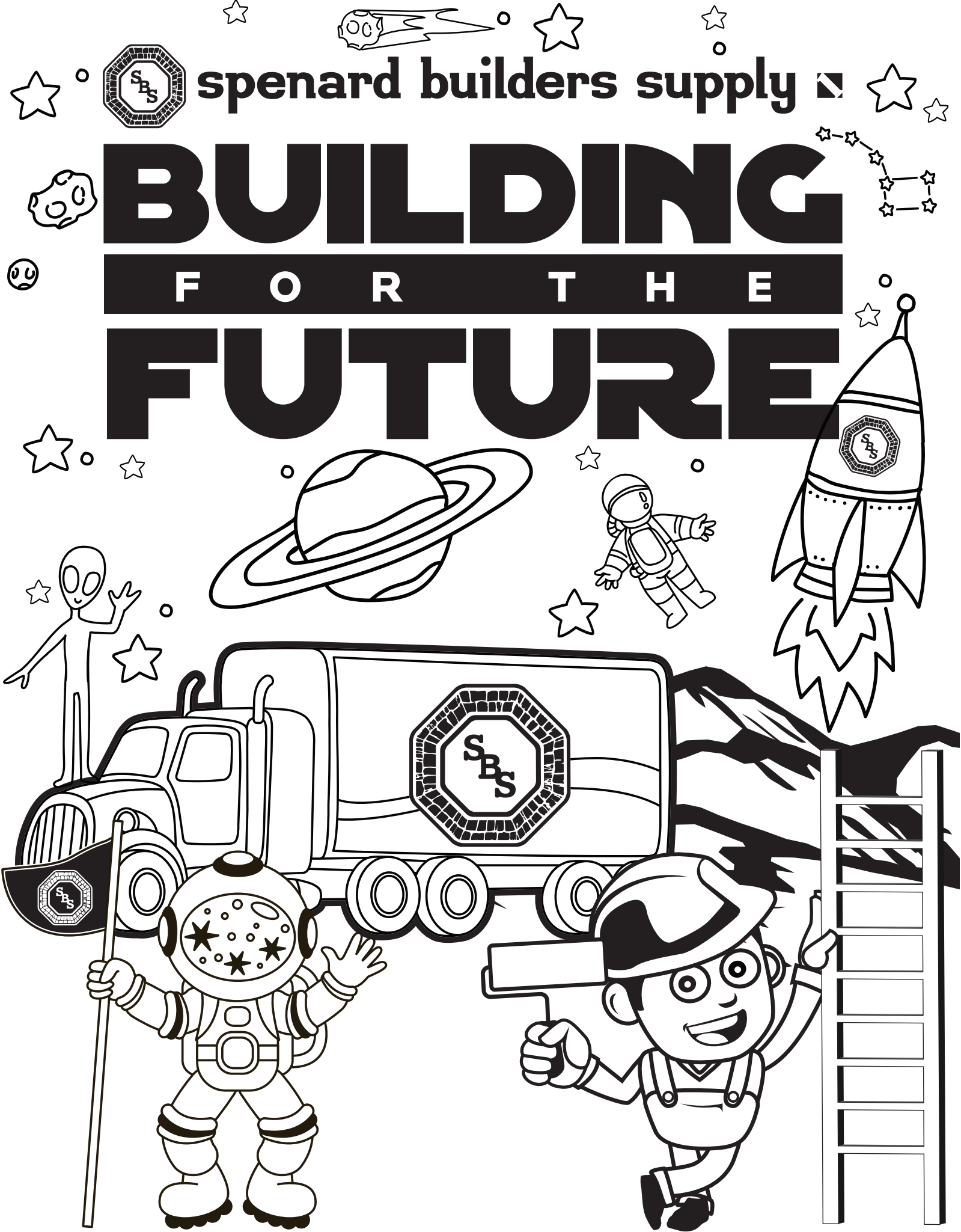





# Alaska Crane

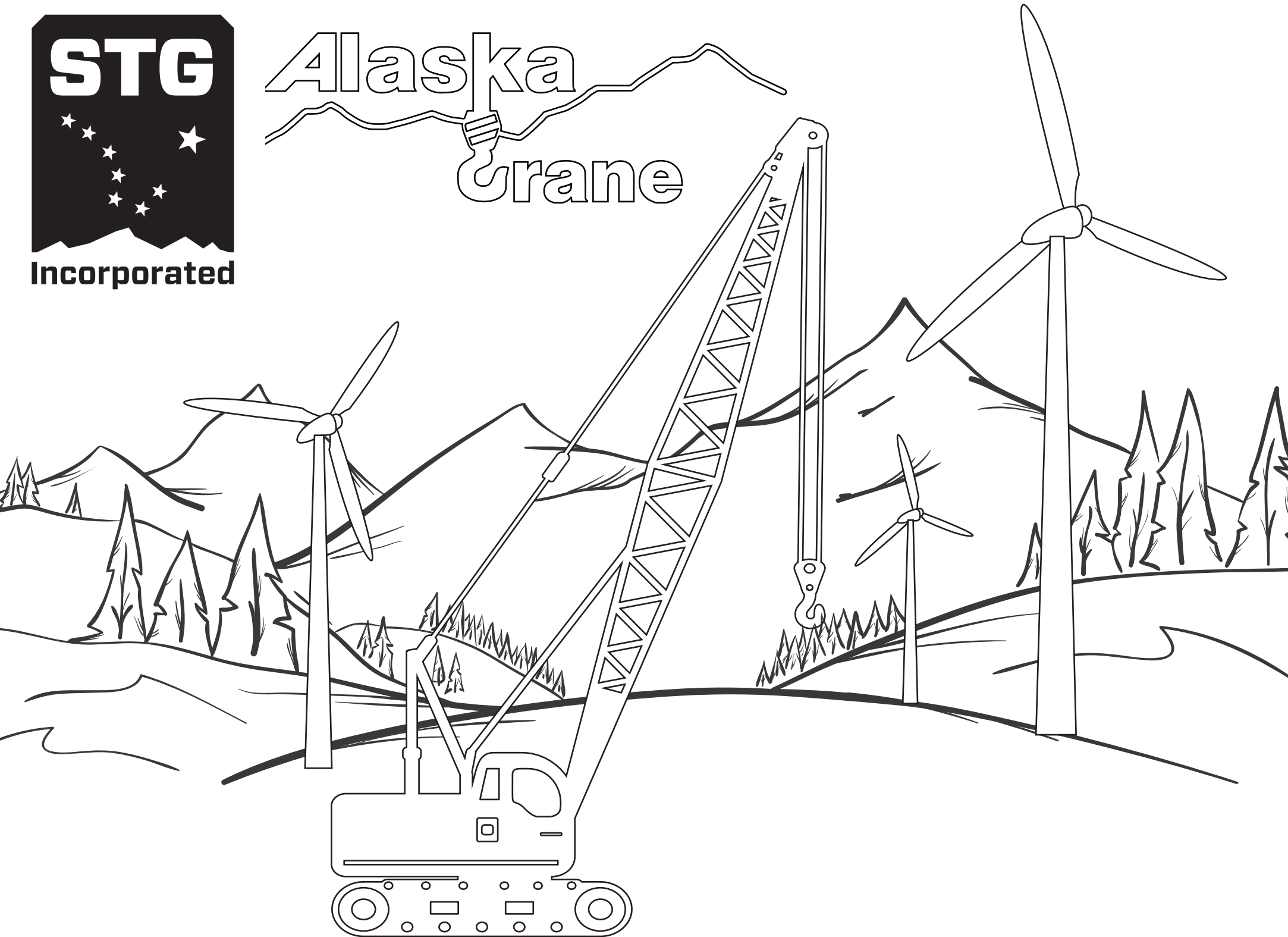

# LEADING THE FUTURE OF ALASKA'S CONSTRUCTION INDUSTRY

The Construction Leadership Council was formed to cultivate the future leaders of Alaska's Construction industry. Through development of strong professional relationships, the group will expand and enhance growth and development of Alaskan communities, carrying forward the tradition of excellence.

## WHO SHOULD JOIN?

Those interested in development of Alaska's construction industry.

## CLC GOALS

-  **PROFESSIONAL DEVELOPMENT**  
Provide quality education programs to our members.
-  **NETWORKING AND SOCIAL EVENTS**  
Give young professionals opportunities to network with peers and other industry organizations.
-  **COMMUNITY PROJECTS**  
Provide opportunities for giving back to Alaska.
-  **INFORMATION**  
Provide access to current industry trends and regulations.
-  **THE FUTURE OF AGC**  
Aid the industry by highlighting future leaders, supporters and voices.



ASSOCIATED GENERAL CONTRACTORS OF ALASKA  
CONSTRUCTION LEADERSHIP COUNCIL  
8005 SCHOON STREET, ANCHORAGE, AK 99518  
AGCAKCLC@GMAIL.COM  
WWW.AGCAK.ORG

© AGC OF ALASKA CONSTRUCTION LEADERSHIP COUNCIL  
ARTWORK EITHER COMPANY-PROVIDED OR DESIGNED BY TRUNK CREATIVE